



Volkswagen Amarok NF Predator & Toro Front Bar Fitting Instruction

IMPORTANT! – READ BEFORE INSTALLATION

- When installed in accordance with these instructions, the front protection bar does not affect the operation of the vehicles SRS airbags.
- This product must be installed exactly as per these instructions using only hardware supplied.
- Take a few moments to read instructions thoroughly before beginning work.
- In the event of damage to any bar component please contact OFFROAD ANIMAL to arrange repair/replacement of components.
- Do not use this product for any vehicle make or model other than that specified on these instructions.
- Do not remove labels from this product.
- This product and its fixings must not be modified in any way unless stated in these fitting instructions.
- The installation of this product is recommended for trained personnel.
- These instructions are correct at time of publication. OFFROAD ANIMAL cannot be held responsible for the impact of any changes subsequently made by the vehicle manufacturer. If you find something has changed please contact us to let us know!
- During installation it is the duty of the installer to check correct operation/clearances of all components.
- If Instructions are to be printed for reference in the workshop, it is recommended that they are printed in colour, for best legibility.

PARTS LISTING

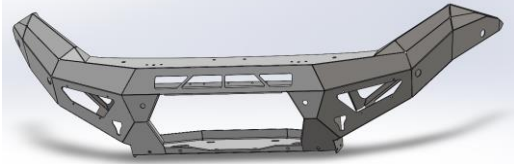
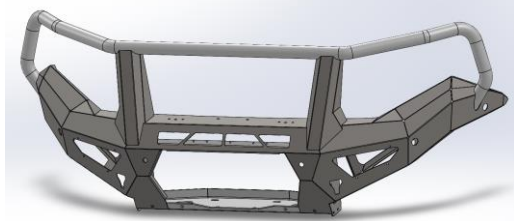
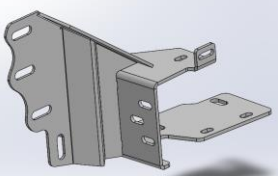
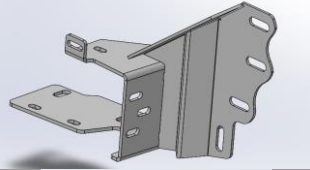
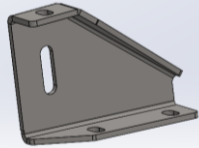
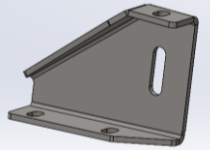
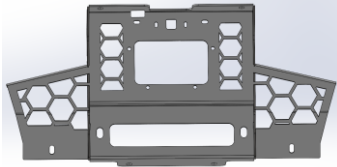

IMPORTANT: Check all parts are present before beginning work! Contact OFFROAD ANIMAL if something is missing.

Main Parts – In the Box

Qty	Part Number	Description	Image
1	FB-VAM-NF-23-PR-ASM1	Amarok NF Predator Welded Bar Assembly	
Or			
1	FB-VAM-NF-23-TOR-ASM1	Amarok NF Toro Welded Bar Assembly	
1	FB-VAM-NF-23-PR-ASM2R	Amarok NF Front Bar Impact Assy	
1	FB-VAM-NF-23-PR-ASM2L	Amarok NF Front Bar Impact Assy	
1	B-1043L	Amarok NF Chassis Brace	
1	B-1043R	Amarok NF Chassis Brace	
1	FB-VAM-NF-23-PR-ASM4	Amarok NF Mesh Fairlead Assy	

1	M-0002L	Light Cover Mesh	
1	M-0002R	Light Cover Mesh	
1	B-0772L	Ford Ranger Next Gen 4 bolt Fog Light Bracket	
1	B-0772R	Ford Ranger Next Gen 4 bolt Fog Light Bracket	
1	U-0070	Amarok NF Centre Bash Plate	
1	U-0071L	Amarok NF Side Underpanel	
1	U-0071R	Amarok NF Side Underpanel	
1	B-1047	Amarok NF Pan Brace	
1	P-0244	Ford Ranger Next Gen Radar Mount Plate	
1	B-0782	Ford Ranger Next Gen Predator - Number Plate Bracket	

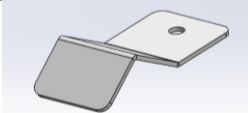

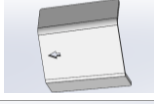
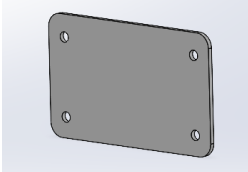
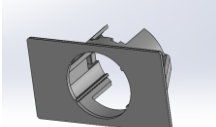
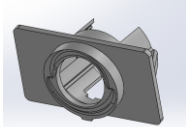
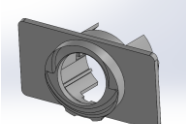
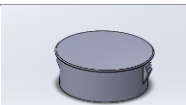
1	B-1048	Amarok NF Grille Support Bracket	
1	B-1065R	Amarok Front Bar - Outer grille support Bracket	
1	B-1065L	Amarok Front Bar - Outer grille support Bracket	
1	N-0004	Ford Ranger P703 Radar Cover Panel	
2	F-0010	Ford Ranger Next Gen Sensor Holder - Straight	
2	F-0011	Ford Ranger Next Gen Sensor Holder - 11 Deg Horizontal	
2	F-0012	Ford Ranger Next Gen Sensor Holder - 15 Deg Horizontal	
2	CPHP020	Plasitc Hole Insert, 28MM, Black, Tigerlink Hardware CPHP020	
1	TK-COM-PSEN-6	Tape Kit - 6 Sensor Universal	No image
1	TK-FB-FRA-NG-22	Tape Kit - Next Gen Ranger Front Bar	No image



Predator Small Parts – Contained in Small Parts Kit Bag

QTY.	PART NO.	DESCRIPTION
4	M8 X 20 BHCS BLACK ZINC	SCREW, BUTTON HEAD CAP, M8X20X1.25, ISO4042 ZnNi BLACK PASSIVATED FINISH
6	M8 FLAT WASHER- BLACK ZINC	M8 FLAT WASHER, 16.5x8.4x1.2, ISO4042 ZnNi BLACK PASSIVATED FINISH
6	M8 X 20 HEX	Bolt Hex, M8X20x1.25, GR8.8 ZP
10	M8 FLAT WASHER	M8 FW
12	M8 FLANGE NUT	Flange Nut, M8x1.25 G8.8 ZP
8	M10 x 25	Bolt Hex, M10X25x[1.5], GR8.8 ZP
10	M10 FW LHD	WASHER, FLAT M10X28.5X2.5
8	M10 FLANGE NUT	Flange Nut, M10x1.5 G8.8 ZP
2	NP-COM-M10-190-ASM0	M10 LOLLYPOP NUT PLATE 190MM LONG
2	M8 X 16 BHCS BZP	SCREW, BUTTON HEAD CAP, M8X16X1.25 GR12.9, ISO4042 ZnNi BLACK PASSIVATED FINISH
40	M6x16 BHCS BLACK ZINC	SCREW, BUTTON HEAD CAP, M6X16X1 GR12.9, ISO4042 ZnNi BLACK PASSIVATED FINISH
40	M6 FLAT WASHER BLACK ZINC	M6 Flat Washer, 12x6.1x1, ISO4042 ZnNi BLACK PASSIVATED FINISH
30	M6 FLANGE NUT	Flange Nut, M6x1 G8.8 ZP
8	M8 HD FLAT WASHER	M8 FLAT WASHER - High Tensile 19x8x1.9mm
2	M8 NYW	Washer, M8, Nylon
2	M8 NYLOC	M8 NYLOC SELF LOCKING NUT, ST STL, ZP
10	M12 FW LHD	M12 FW Large Heavy Duty
8	M12X30	Bolt Hex, M12X30x1.75, GR8.8 ZP
6	M12 FLANGE NUT	Flange Nut, M12x1.75 G8.8 ZP
2	M12 Nyloc nut	M12 NYLOC NUT, 1.75P
6	M8 X 25 HEX	Bolt Hex, M8X25x1.25, GR8.8 ZP
10	M6CN3MM	CAGE NUT M6x2.6-3.5
4	M8 X 12 HEX	Bolt Hex, M8X12x1.25, GR8.8 ZP
3	M10X25 BHCS	SCREW, BUTTON HEAD CAP, M10X25X1.5 GR12.9 ZP

Toro Additional Parts

QTY.	PART NO.	DESCRIPTION
2	B-0649	Toro Antenna Bracket - 90 Degree Tall
4	M8 X 20 BHCS BLACK ZINC	SCREW, BUTTON HEAD CAP, M8X20X1.25, ISO4042 ZnNi BLACK PASSIVATED FINISH
4	M8 FLAT WASHER- BLACK ZINC	M8 FLAT WASHER, 16.5x8.4x1.2, ISO4042 ZnNi BLACK PASSIVATED FINISH



TOOLS REQUIRED

The following tools will be required to install the product.

Hand Tools	Power Tools	Workshop Supplies
Metric Socket Set 8-19mm Socket Extension Bar Metric Spanner Set 10-19mm Hex (Allen) Key Set 4-6mm Torx Key Set Trim Puller Tool Flat Blade Screwdriver set Phillips Head Screwdriver set Utility Knife Side Cutters Pliers	Electric/Air Impact Driver (Optional) Air Hacksaw Or Oscillating Multi Tool Or Angle Grinder	Panel Stand or Soft Blanket Cable Ties Masking Tape Black Automotive paint Scotch Brite or Fine Sandpaper

WORKSHOP SAFETY

It is the responsibility of the installer to always complete works in a safe manner. Make sure the following safety equipment is available and precautions are observed whilst fitting this product.

<p>Hearing Protection</p> 	<p>Always wear ear protection when using power tools.</p>
<p>Eye Protection</p> 	<p>Ensure eye protection is always worn when cutting or drilling.</p>
<p>Manual Handling</p> 	<p>Do not attempt to lift bar assemblies or rock sliders on your own.</p> <p>Always use two people to lift or use mechanical Lifting aid such as hydraulic lifting trolley.</p>
<p>Vehicle Support</p> 	<p>Always ensure vehicle is properly supported when working on it. Do not attempt to fit products whilst suspension work is being carried out. Do not work under a vehicle supported only by a jack.</p>

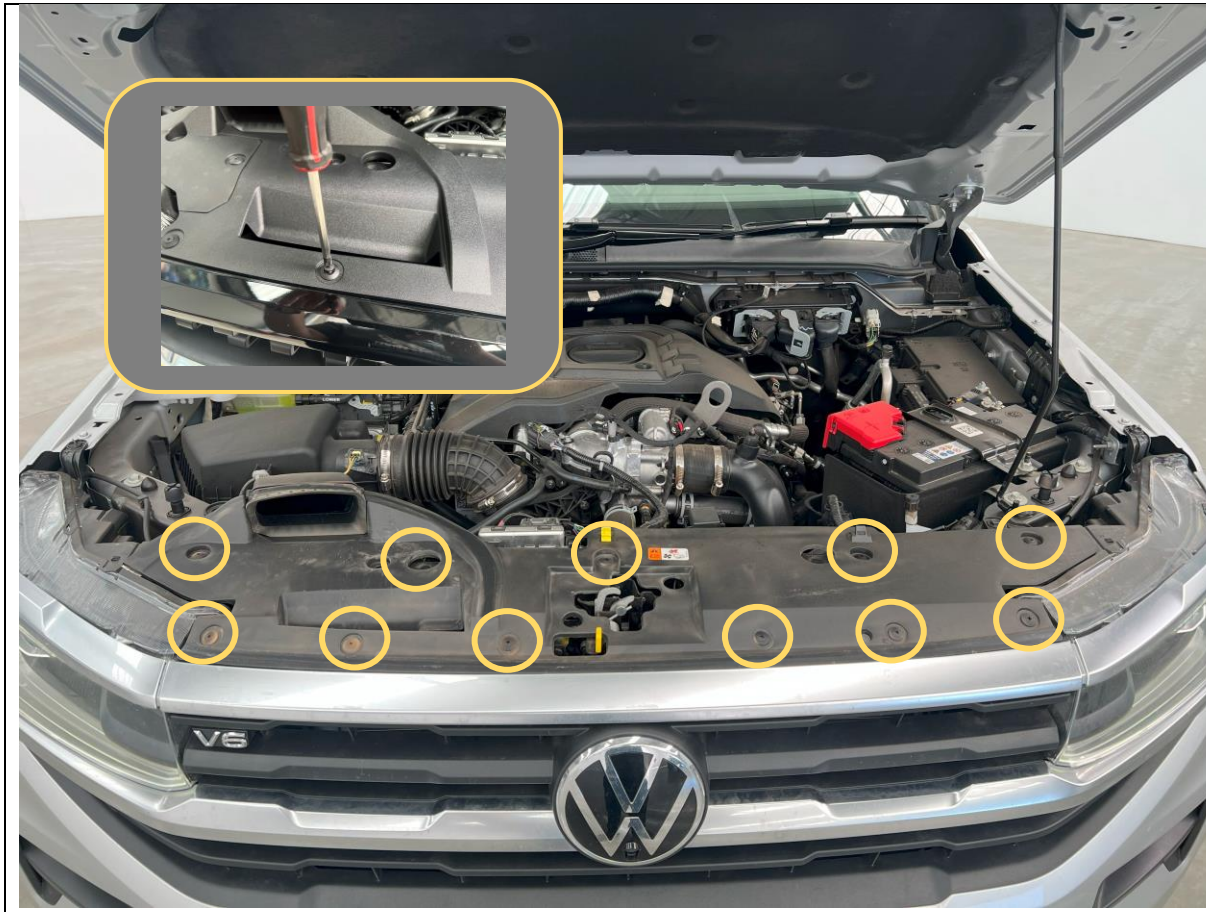





1. **If Relocating Front Camera – Read and understand camera relocation bracket instructions before beginning work.**
2. **DO NOT turn on or move car whilst any camera or radar systems are disconnected. Failure to observe this precaution will result in system errors that will need car to be taken to Volkswagen Dealership to resolve. Keep proximity keys away from vehicle and out of range to minimize the chances of computers activating whilst modules are disconnected.**
3. Open the Bonnet
4. Remove scrivets securing the top radiator cowling. Unscrew center section with Phillips screwdriver to unlock, then remove clip with trim tool.
5. Retain all clips for reassembly

TOOLS REQUIRED

Trim Tool
Phillips Screwdriver

FASTENERS

Retain Factory

<p>Front Camera Equipped Cars. Camera Connector +Washer Tube</p> 	<p>Electrical Connector</p> 
<p>Clamp Washer hose to prevent Spills</p> 	<p>8mm Socket for Grille Bolts</p> 
<ol style="list-style-type: none"> 6. Disconnect the main electrical harness connector camera, camera connector and camera washer fluid connector (360 Camera equipped vehicles) 7. Remove the 2x Bolts securing top of grille to body using 8mm socket. 	<p>TOOLS REQUIRED</p> <p>8mm socket or spanner.</p> <hr/> <p>FASTENERS</p> <p>Retain Factory</p>



8. Remove the 8mm deep head screws securing the bumper to the lower crossmember. The other shallower head screws do not need to be removed
9. Remove the Torx screw that secures the bottom of the flare to the bumper.
10. Complete for both sides of the vehicle.

TOOLS REQUIRED

8mm socket
T25 Torx Driver

FASTENERS

Factory Bolts (Discard)

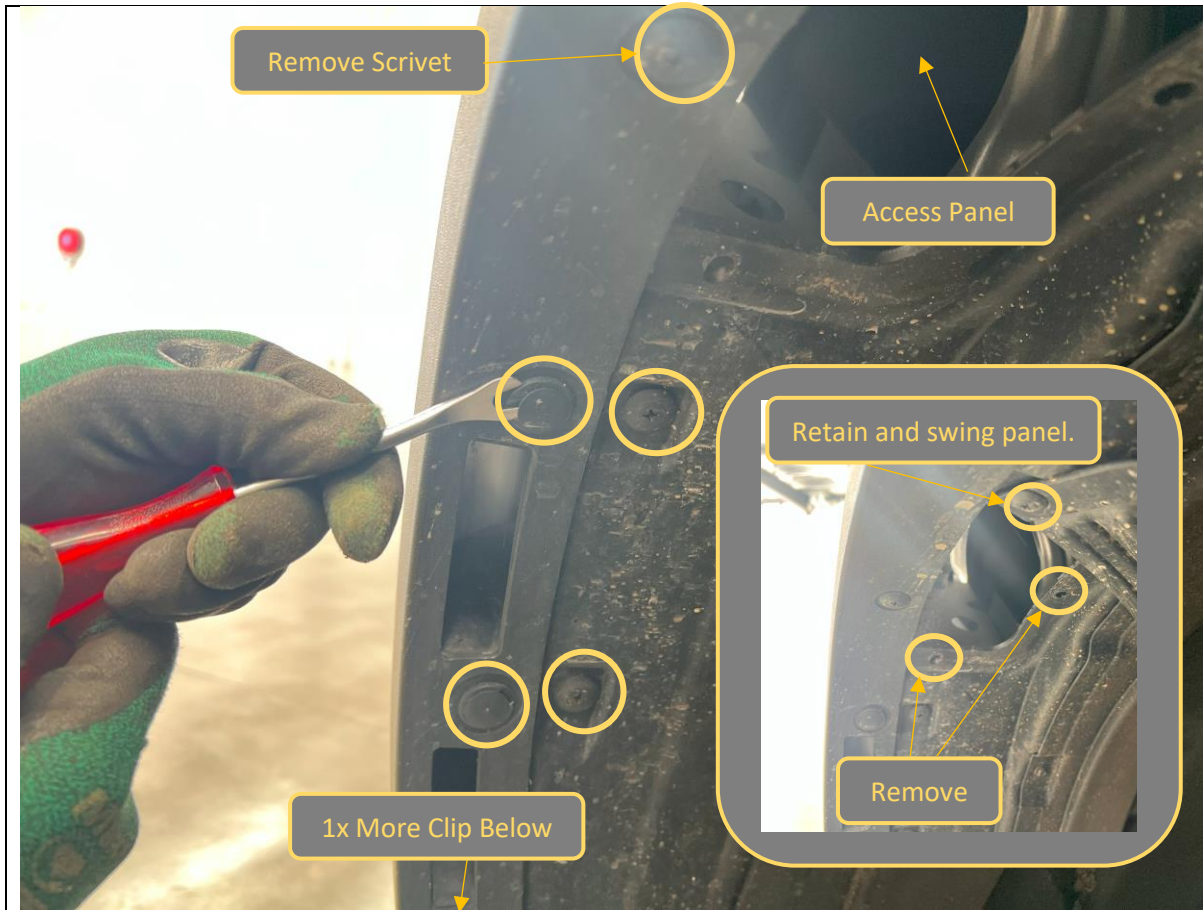

11. Remove clips securing wheel arch flare and inner guard liner by prying up center part of clip using a trim tool.

12. There are 4x flat head clips securing each flare.

13. Also remove the first two scrivets securing top of the flare to the fender panel.

14. Remove the scrivets shown in the wheel arch.

15. Remove the lower two scrivets on the access panels on the wheel arch liner. This will allow the access panel to swing away giving access to the bumper bolts.

TOOLS REQUIRED

Trim Tool
Phillips Screwdriver

FASTENERS

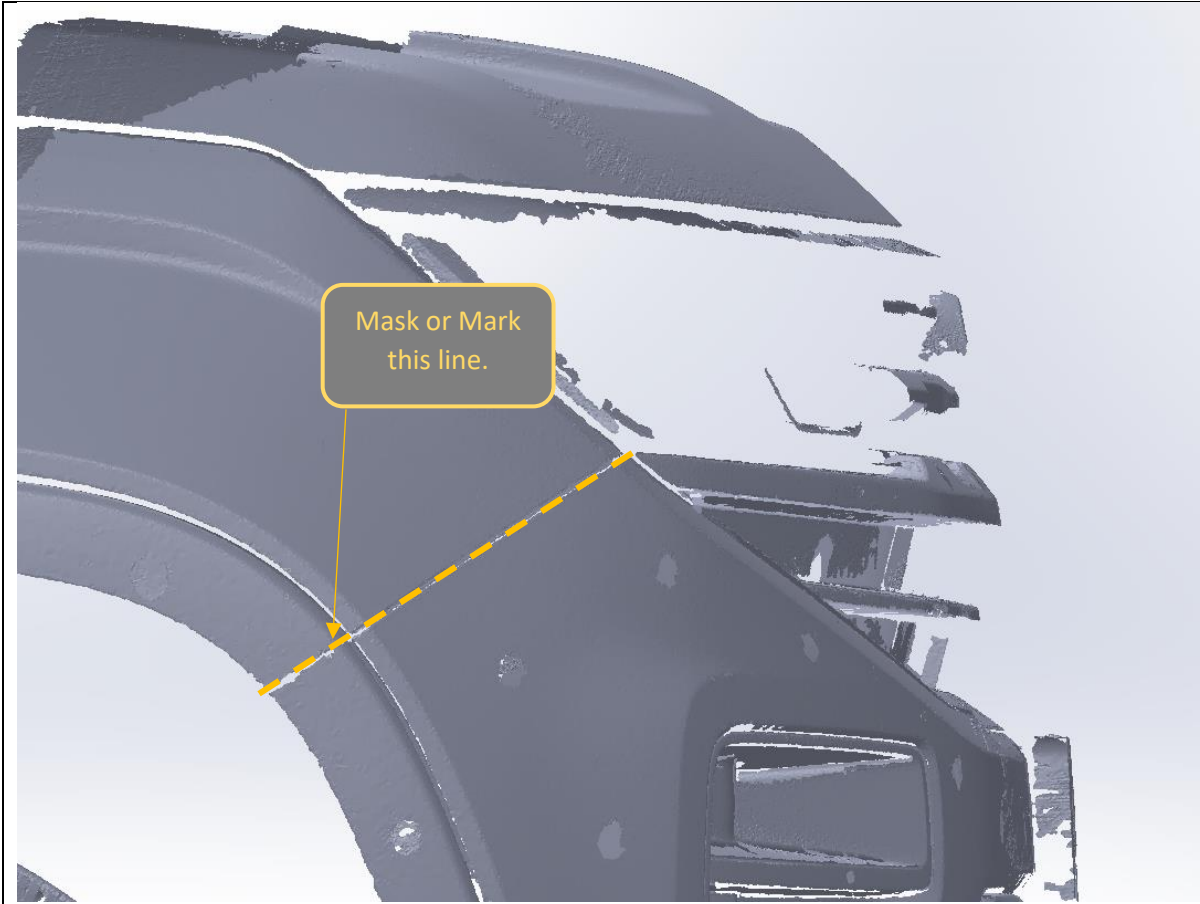

16. Before removal of the flare, place masking tape / mark the flare in line with the bumper to guard panel line, this will assist in trimming flare later.

TOOLS REQUIRED

Masking Tape or
Marker

FASTENERS



<p>17. Progressively release the clips securing the wheel arch flare to the bumper. Start from the bottom corner of the flare towards the front of the vehicle. Stop once the flare is free from the front guard.</p>	<p>TOOLS REQUIRED</p> <p>Trim Tool</p>
<p>18. IMPORTANT: Remove the two concealed scrivets behind the flare securing the arch liner to the bumper</p> <p>19. For high spec vehicles with 6x Parking sensors, remove the sensor from the housing in the flare and temporarily stow sensor in bumper.</p>	<p>FASTENERS</p> <p>Factory Clips</p>



20. Remove the grille from the vehicle.

21. The grille is secured by molded clips in the locations shown in the photo above.

Firmly pull the grille away from the bumper to release the clips.

Start from mid way at bottom as shown and progressively release the clips to enable the grille to be removed.

22. Panamericana and Aventura models have slightly different grille. You will need to remove the number plate plinth before removing the grille.

23. **If Relocating Front Camera – Camera and washer can be removed from grille. Refer to Camera relocation kit instructions.**

TOOLS REQUIRED

FASTENERS

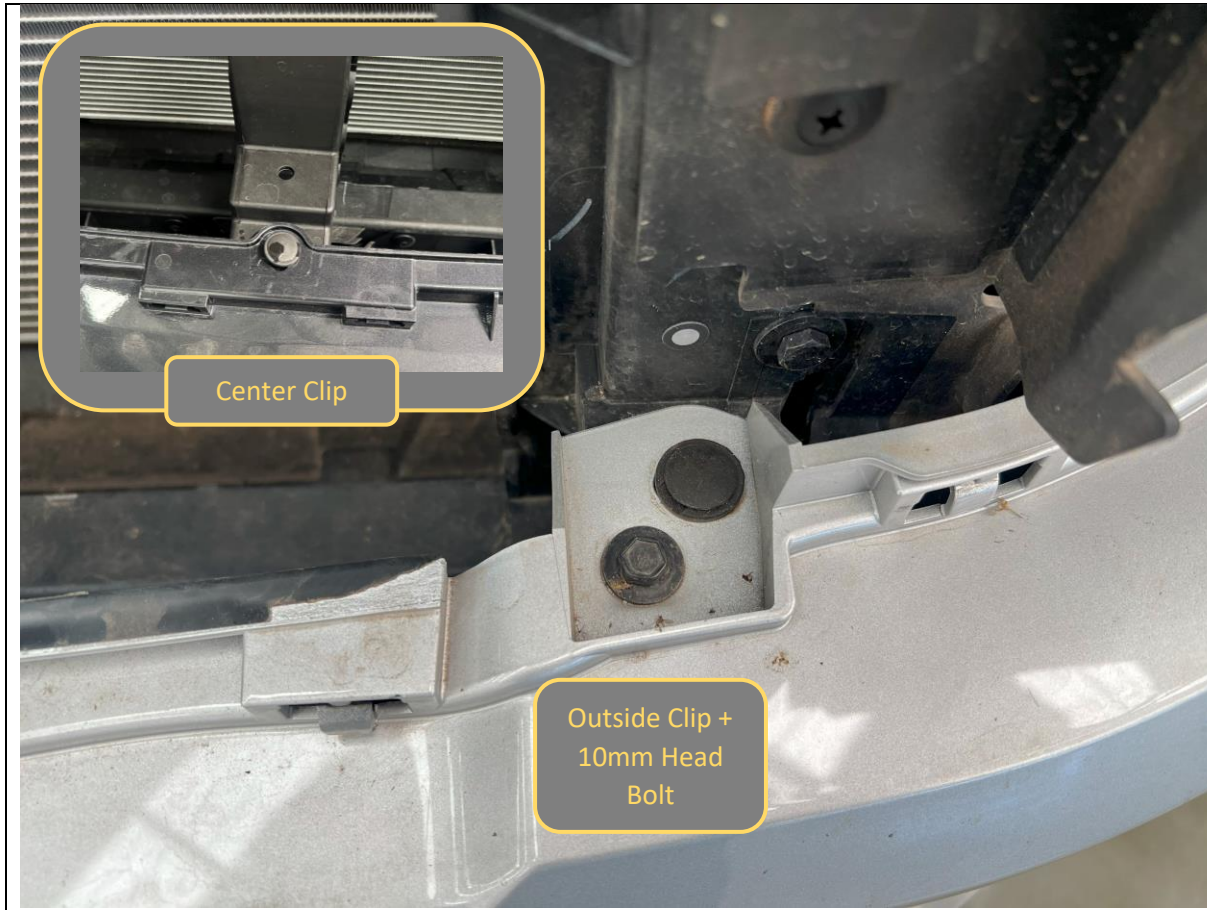

24. Remove 10mm head bolt and clip securing the bumper from each edge underneath the grille.
25. Remove the clip securing the center of the bumper to the radiator support.

TOOLS REQUIRED

10mm Socket
Trim Tool

FASTENERS

Factory Fasteners - Discard



26. Unclip the main wiring harness from all locations where it is secured the radiator support panel.

TOOLS REQUIRED

Trim Tool

FASTENERS

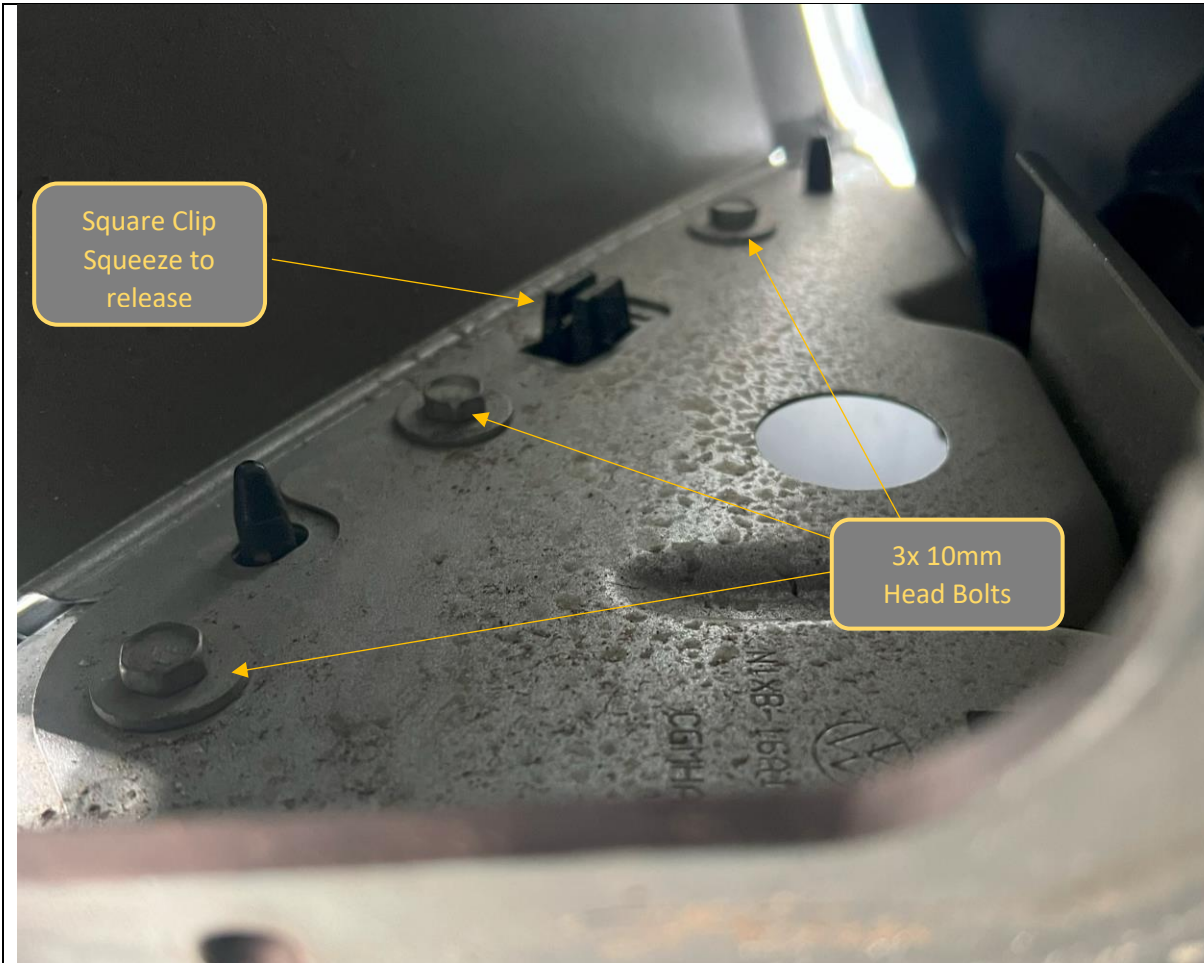

27. Looking through the access hatch on the wheel well liner you can see the 3x 10mm head bolts securing the bumper to each side of the vehicle.

Remove these 3 bolts. A mini ¼ drive ratchet is the best tool for this job. Complete on both sides.

28. Squeeze the sides of the square retaining clip whilst applying gentle downward pressure to the bumper. This may be easier using pliers to squeeze the clip.

TOOLS REQUIRED

10mm Mini ratchet
Pliers

FASTENERS

Factory 10mm head screws, retain for fitment of infill panels.



29. Once the clips are released, remove the bumper from the vehicle and set down on a soft surface such as blanket or panel stand.

TOOLS REQUIRED

FASTENERS

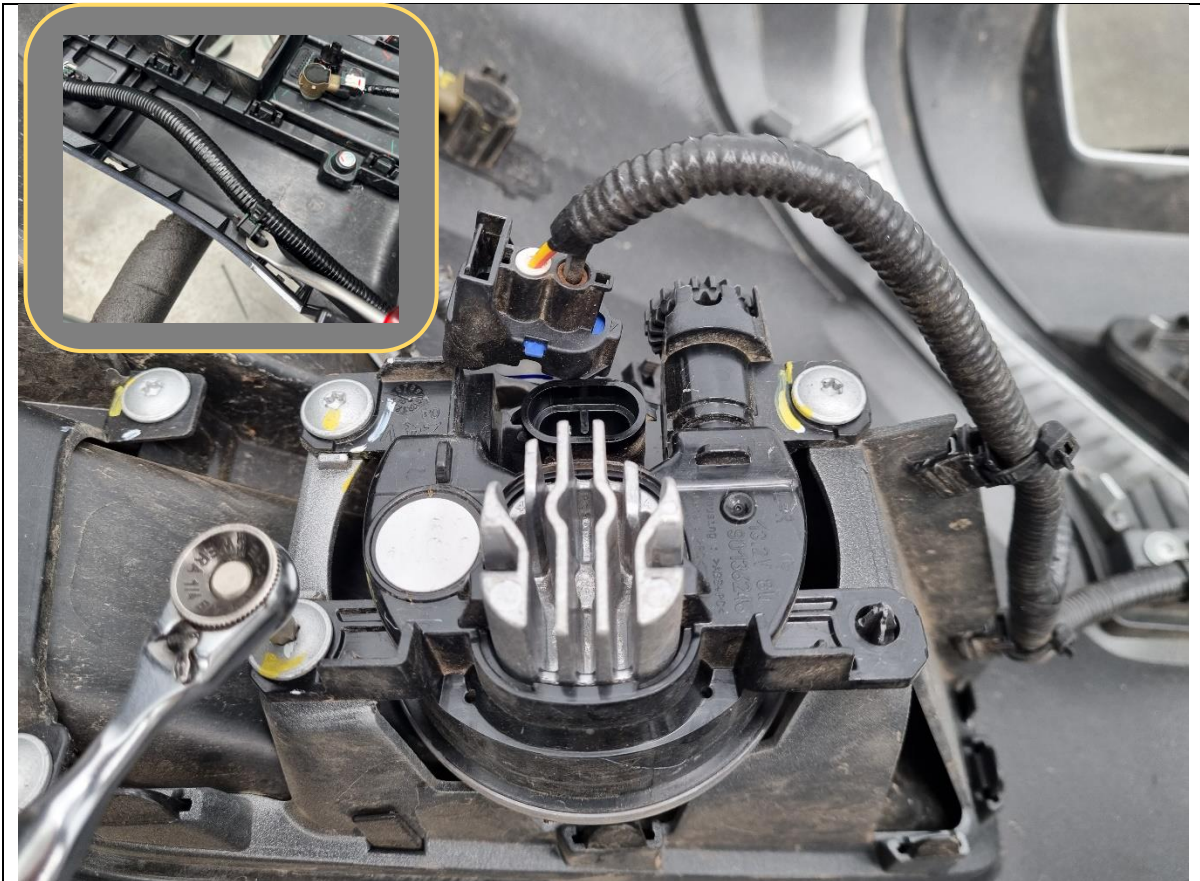

30. Disconnect the Fog light harness from the fog light.
31. Remove the fog lights from the bumper, by removing the three Torx head screws.
32. Remove the electrical harness from the bumper by prying out the clips using trim tool.
33. Complete on both sides of bumper.

TOOLS REQUIRED

Torx Head Screwdriver
Trim tool

FASTENERS

Discard Factory Screws

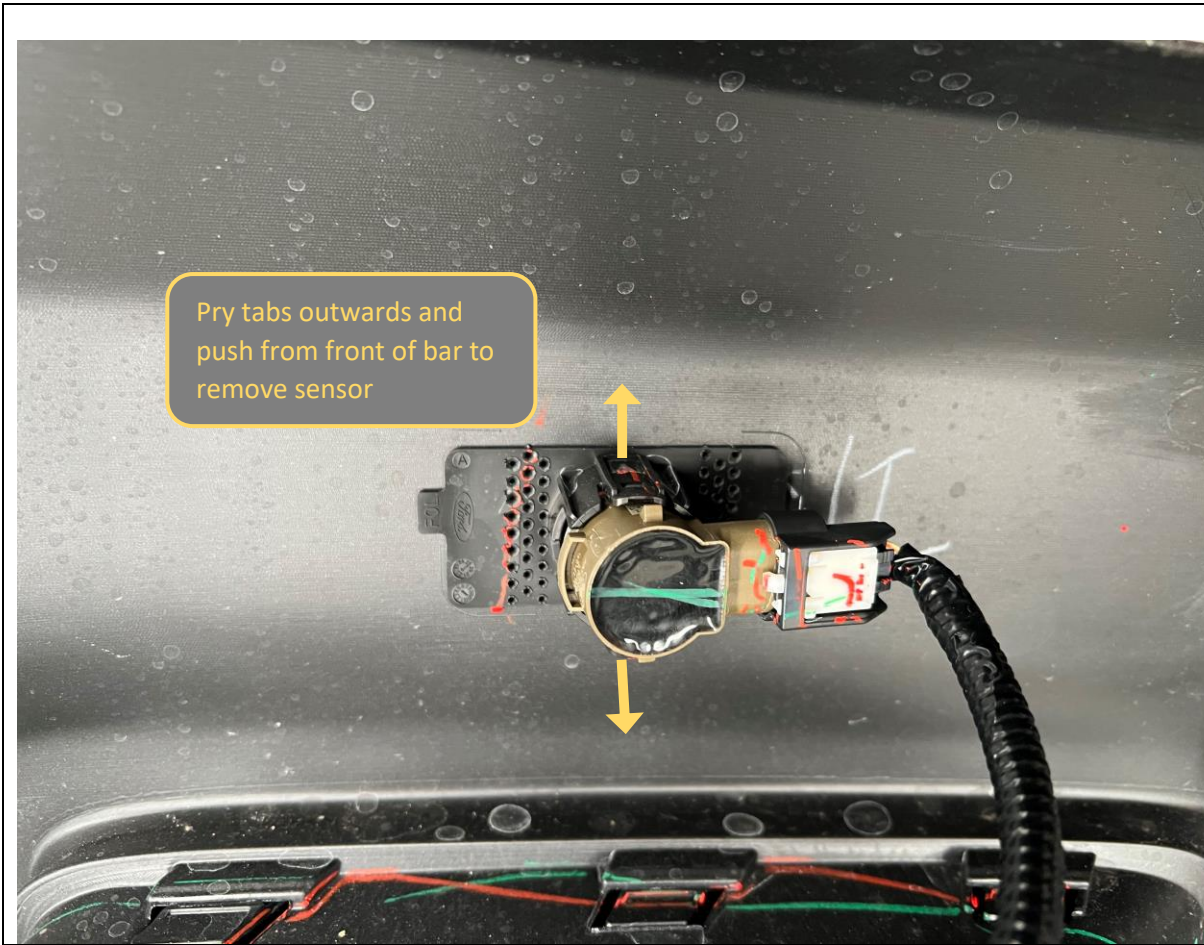

34. Pry the two black retaining tabs on the parking sensor housing outwards whilst applying pressure to the face of the sensor from the front side of the bumper. The sensor should release from the housing. Remove from the rear side of the bumper.

Take care to ensure the rubber isolation rings remain in place with the sensor

TOOLS REQUIRED

FASTENERS

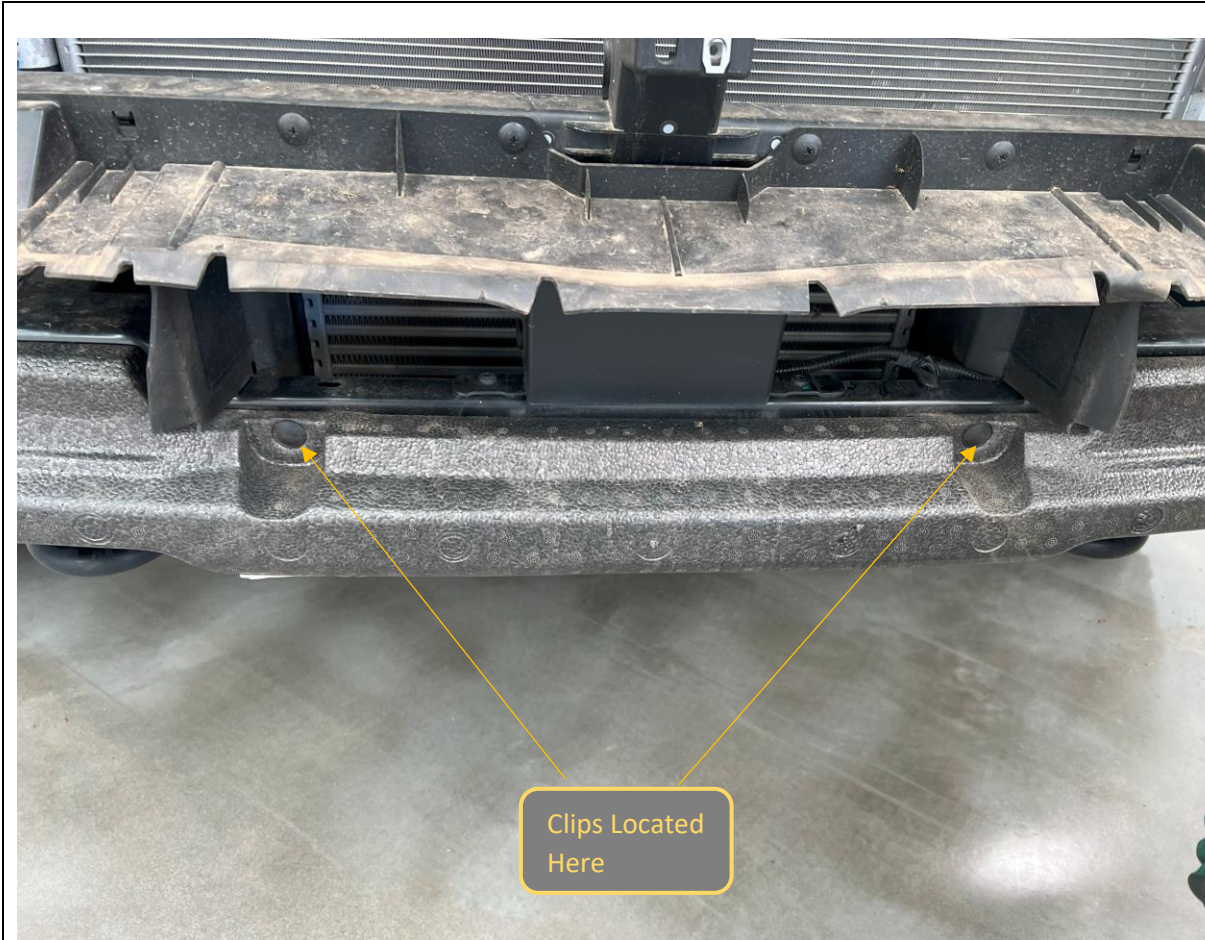

- 35. Remove the Foam covering the impact beam.
- 36. The plastic is secured by clips in the front face, and molded clips on either end of the beam. Remove the visible clips and pull to remove.
- 37. Remove and set aside the foam impact beam.

TOOLS REQUIRED

FASTENERS

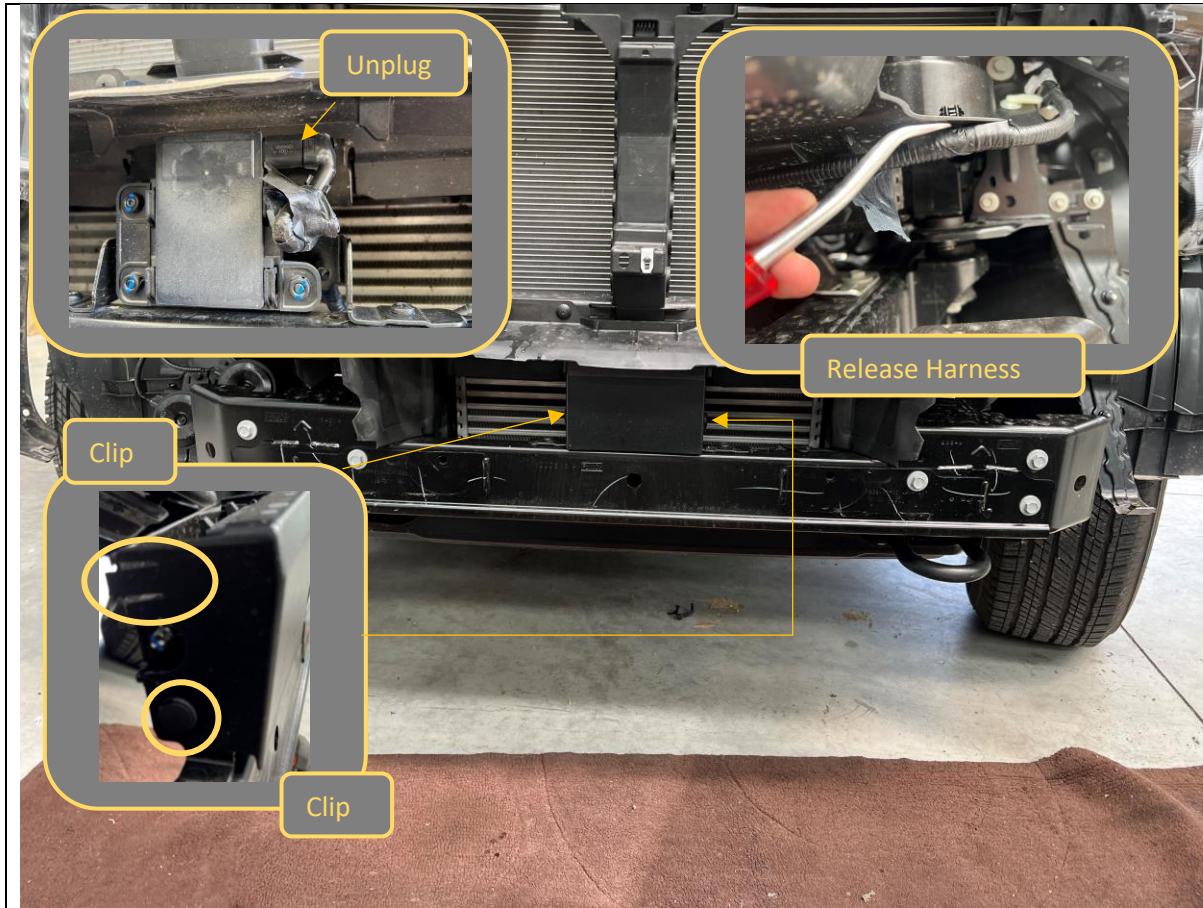

38. Remove the Plastic radar cover by removing the two clips securing the bottom on the sides and two molded clips on the top side.

39. Unplug the radar module wiring harness connector.

40. Release all clips securing the radar wiring harness to the impact beam and plastic air guides using a trim tool.

TOOLS REQUIRED

10mm socket / spanner
Trim tool

FASTENERS



41. Remove Impact beam by removing the 6x M8 Bolts securing it to the chassis.
42. Retain bolts for fitment of impact assemblies.
43. Mark the plastic air guide through the narrowest points as shown by the red dashed lines on the images above.

TOOLS REQUIRED

13mm socket / spanner

FASTENERS

Factory M8 Flange Bolts - Retain

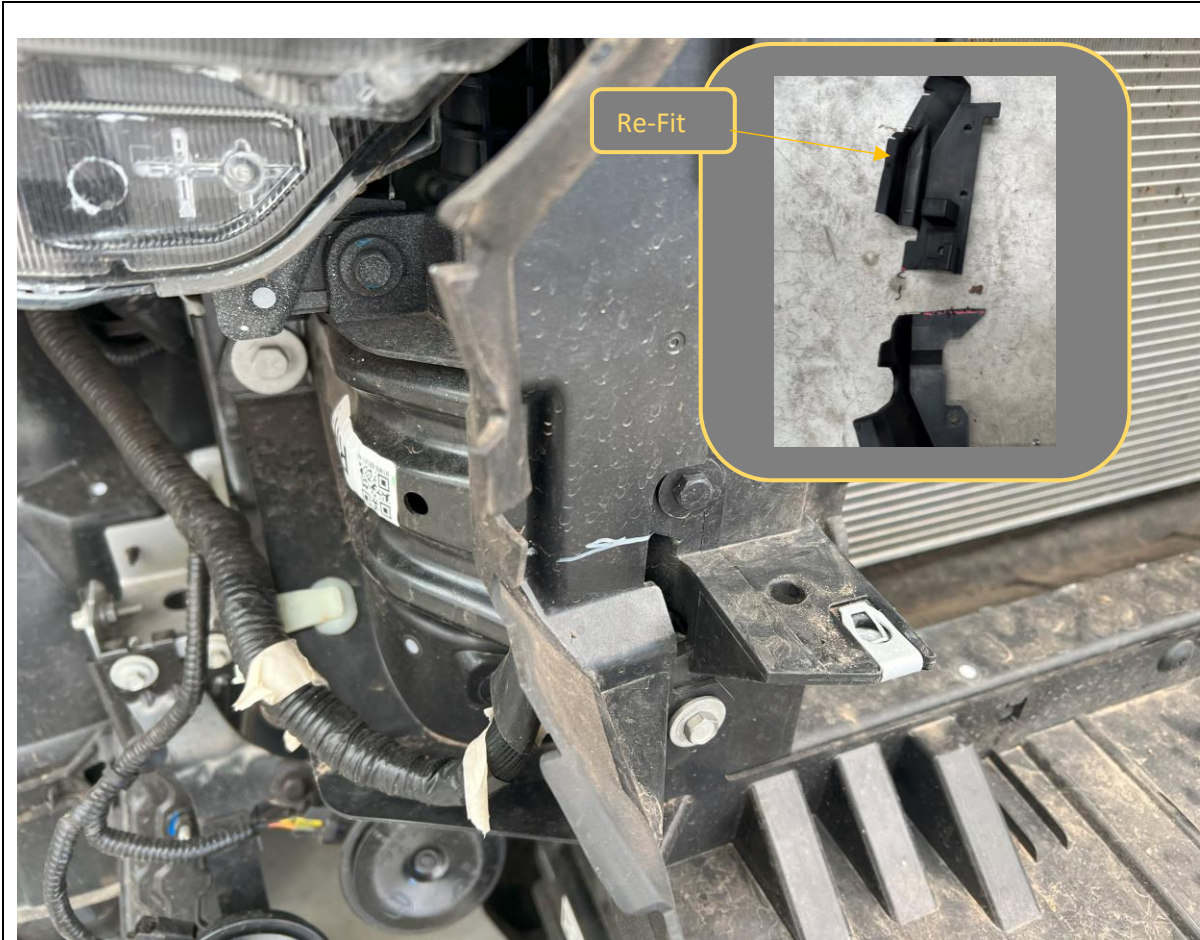

44. Remove the plastic air guide by removing the scrivets and 10mm head bolts securing to the vehicle.
45. Trim the air guide along the line marked earlier and re-fit top portion to car using original fasteners.

TOOLS REQUIRED
Trim Tool
Phillips Screwdriver
10mm Socket

FASTENERS

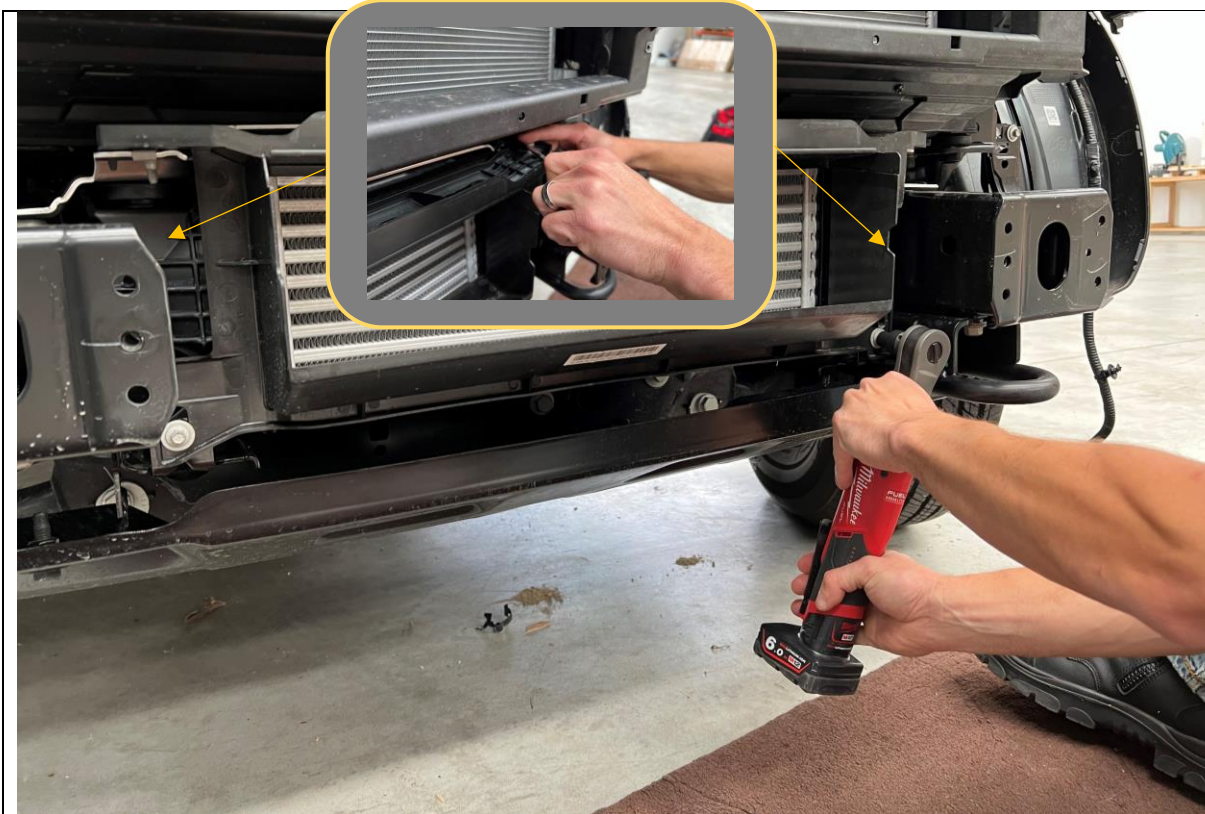

46. Remove Intercooler air guide by removing the 4x bolts (2x top 2x front) securing it.

TOOLS REQUIRED
8/10mm Socket
8/10mm Spanner

FASTENERS
Factory Flange Bolts

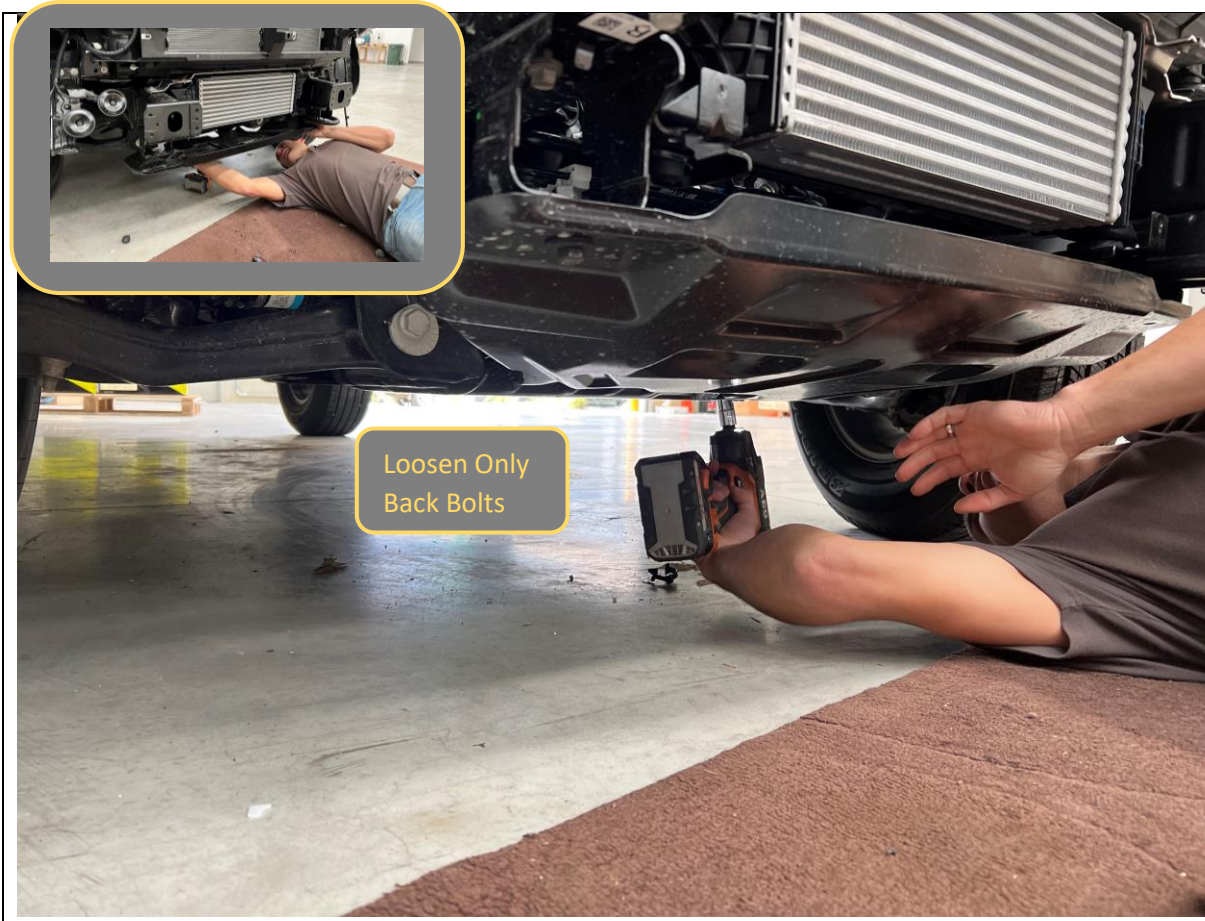

<p>47. Remove lower bash plate.</p> <p>48. First loosen only the rear 15mm head factory flange bolts.</p> <p>49. Whilst supporting bash plate remove two front bolts. Then remove bash plate toward front of the car.</p>	<p>TOOLS REQUIRED</p> <p>15mm Socket</p>
	<p>FASTENERS</p> <p>Factory Flange Bolts - Retain</p>



50. Temporarily support the intercooler by strapping to the upper intercooler support brackets.

51. This is best done with relatively short camlock straps or similar, Ensure the straps do not obstruct the lower rubber intercooler mounts

TOOLS REQUIRED

Camlock Straps

FASTENERS

Phillips Head screw.
Discard



- 52. Remove the two 15mm head factory flange bolts securing the factory tow point / intercooler supports on both sides.
- 53. An extension bar can make reaching the rearmost bolt easier.
- 54. Retain factory Flange Bolts for Re-Fitment

TOOLS REQUIRED

15mm Socket / Spanner
Extension Bar

FASTENERS

Factory Flange Bolts - Retain

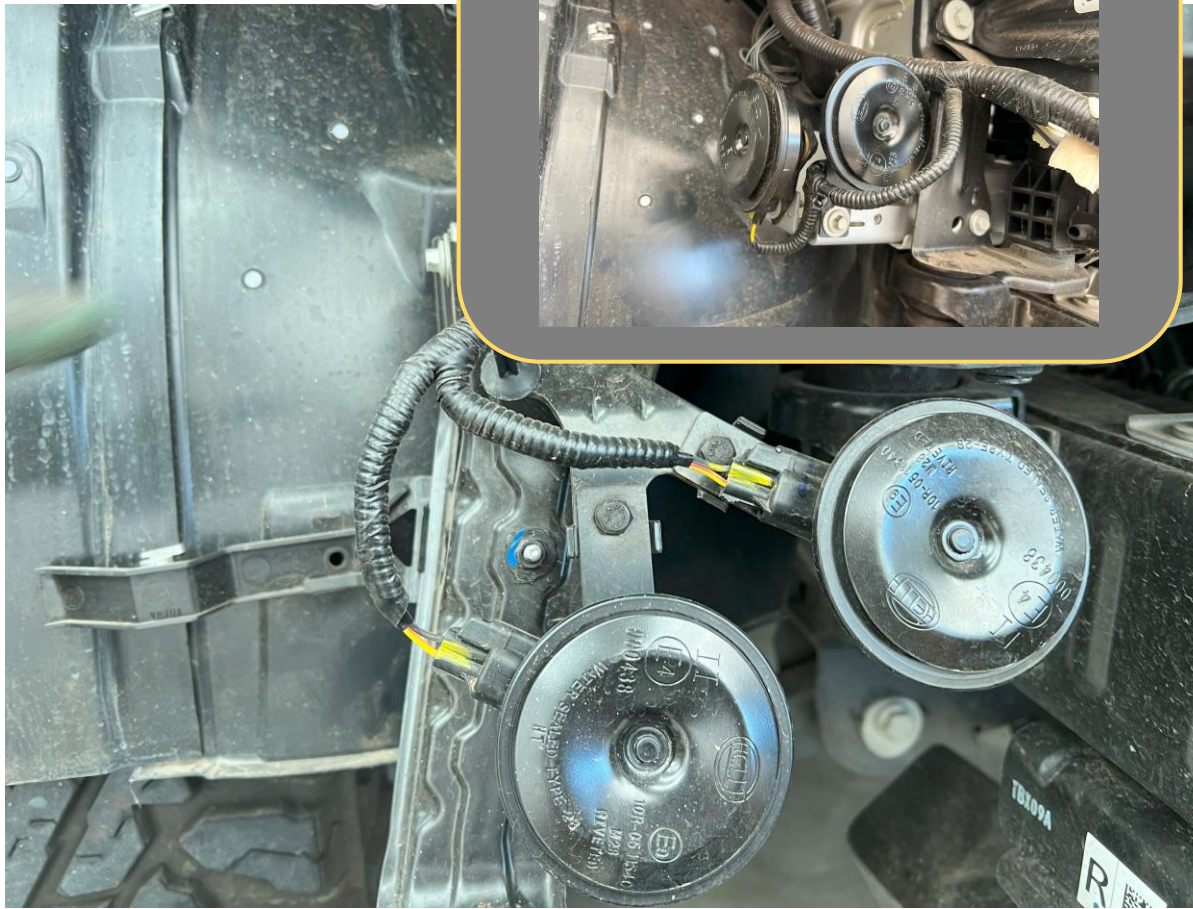

55. Remove the dropper bracket securing the horns to the body under the headlight on the RHS side. Also remove dropper bracket on other side of vehicle.

56. Remove the horns from the bracket and re-fit, in inverted position to the captive nuts in the body the dropper bracket was removed from, using original fasteners.

TOOLS REQUIRED

8/10mm Socket / Spanner

FASTENERS

Factory Flange Bolts - Retain



- 57. Identify and unpack the Impact assemblies.
- 58. Loosely fit the impact assembly to the vehicle chassis.
- 59. Secure from below with Factory Flange bolts through the factory tow points. Leave bolts loose at this stage.

TOOLS REQUIRED

FASTENERS

2x Factory Flange Bolt

Per side

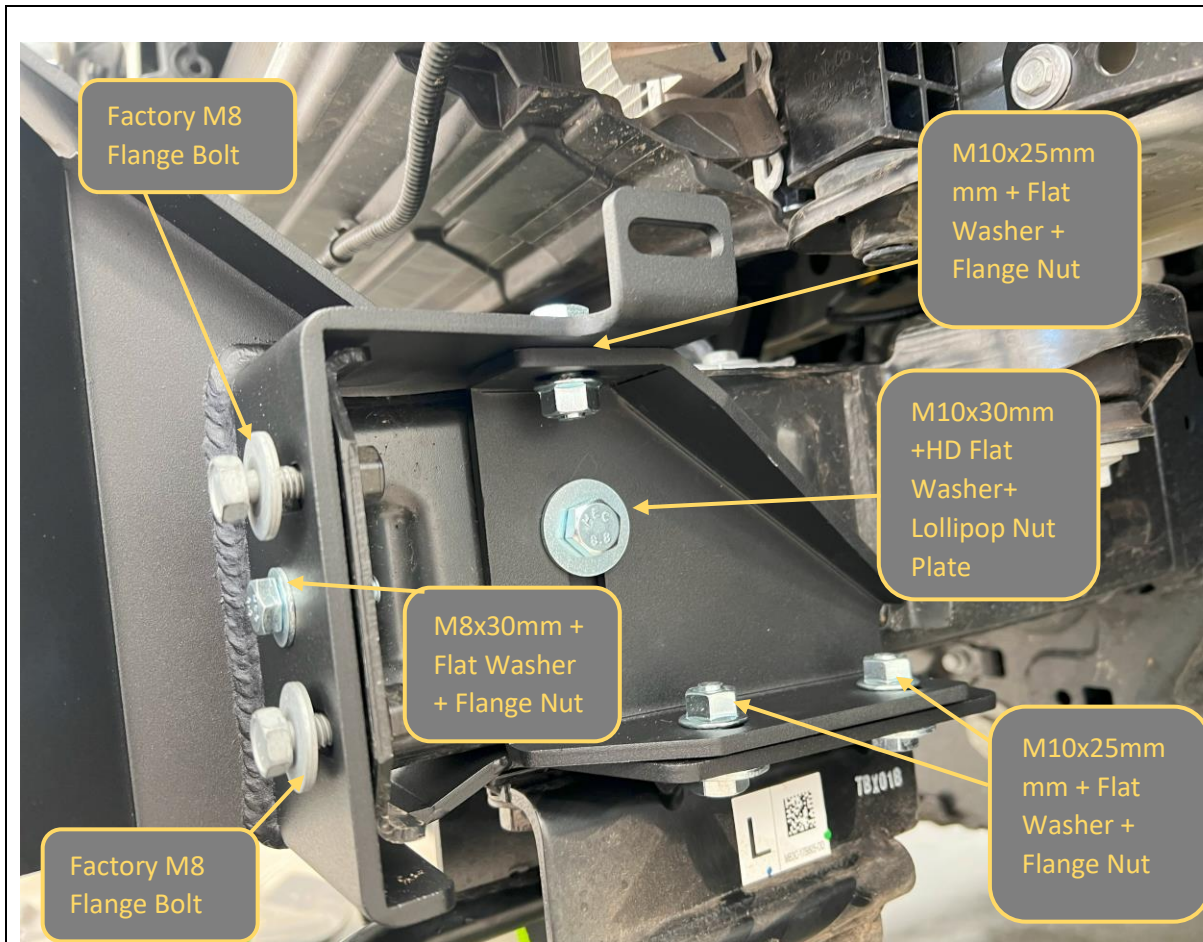

60. Fit Remainder chassis brace and remainder of bolts to tow point and impact assembly as shown in above image.
61. Re-use Factory M8 Flange bolts from impact beam in locations where captive nuts are in chassis rail.
62. Leave all bolts that secure tow point and impact assembly, including the bottom flange bolts that go through chassis loose at this stage.
63. Repeat on other side of vehicle

TOOLS REQUIRED

FASTENERS

As shown in image

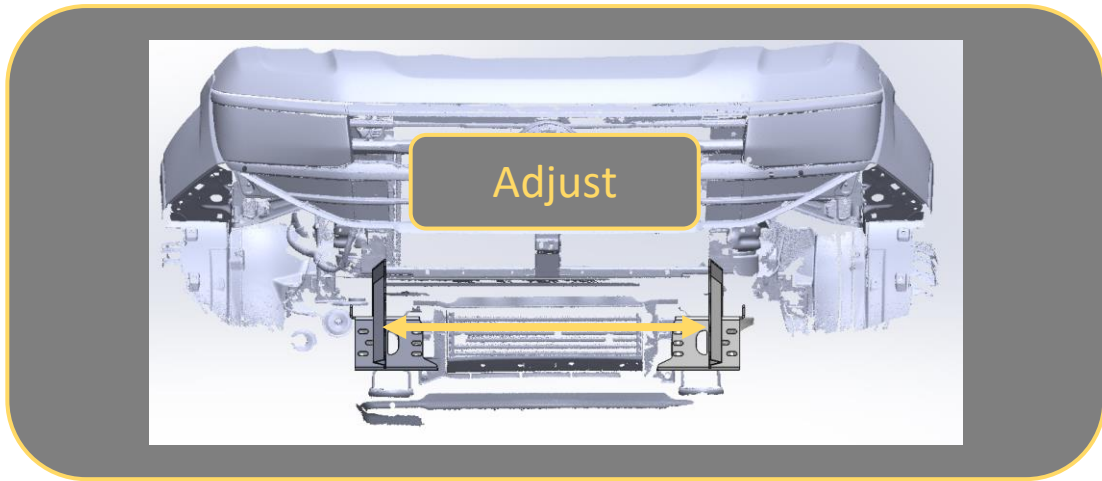
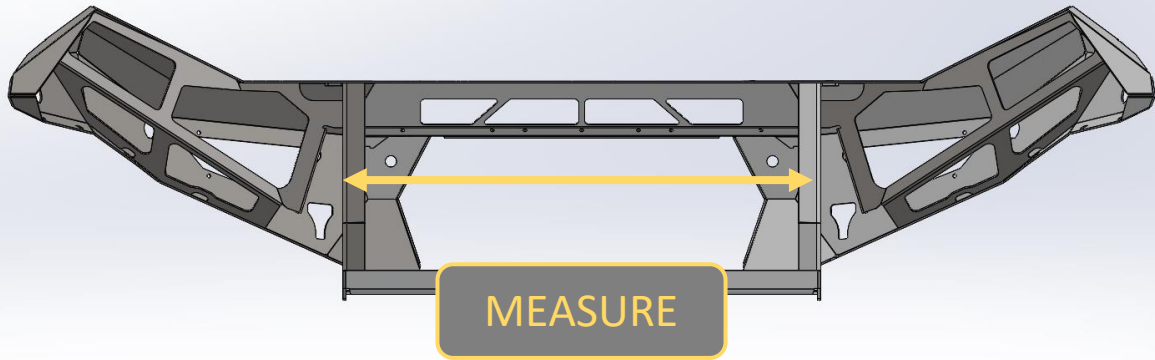

64. Measure Distance between outside edges uprights on bar using tape measure. Write distance below for reference if required.

Bar Upright Width = _____mm

65. Adjust mounts by sliding mounts on slots, such that distance between inside edges of mounts is approximately 2mm greater than the bar.

66. Secure and tighten mounts. Tighten bolts that secure the chassis brace to chassis first, then tow point to chassis bolts, then impact assembly to chassis bolts and finally impact assembly to chassis brace bolts.

TOOLS REQUIRED

TAPE MEASURE
13, 15 & 16mm Spanner /
Socket

FASTENERS



67. Prepare bar for fitment. Start by routing the Wiring harness through the bar such that all plugs are in the correct location. The main harness connector should sit to the OUTSIDE of the bar upright on the LH side of the vehicle.

68. Fit the fog lights to the fog light brackets using supplied M6x16 black button head bolts and flange nuts.

69. Fit the fog light brackets to the Mesh Panels, using the supplied M8x12 Bolts. Fog lights should face straight ahead when fitted.

TOOLS REQUIRED

4mm Allen Key
10mm Spanner / Socket

FASTENERS

4x M6x16 BHCS – Black
4x M6 Flat Washer
4x M6 Flange Nut
per Side
2xM8x12
2xM8 Flat Washer
2x M8 Flange Nut



70. Fit Light mesh panels to the bar using M6X16 Button head Bolts, Flat washers, and Flange nuts from the Small Parts Kit.

71. Secure and tighten using 4mm Allen Key and 10mm Spanner

TOOLS REQUIRED

4mm Allen Key
10mm Spanner / Socket

FASTENERS

4x M6x16 BHCS – Black
4x M6 Flat Washer
4x M6 Flange Nut
Per Side



72. Fit 5x Cage nuts from small parts kit to rectangular slots in bottom of wing.
- Use a small flat bladed screwdriver to push the edge of the cage to engage with the slot to aid fitting.
73. Repeat for other side of Bar

TOOLS REQUIRED

Small Flat Bladed Screwdriver

FASTENERS

5x M6 Cage Nut
Per side

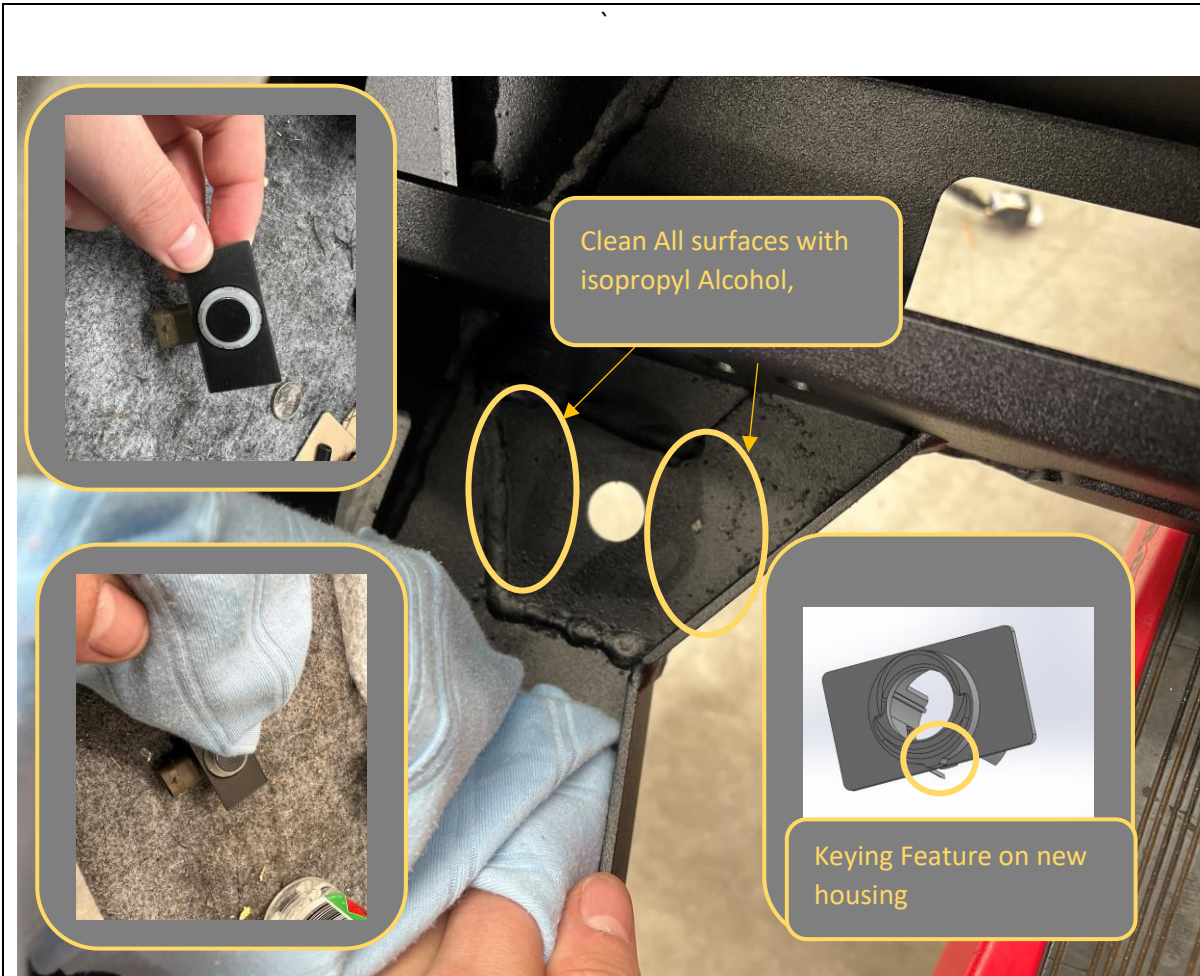

74. Re Fit parking sensors to the bar using the following procedure

75. Clean area on back side of bar adjacent to sensor holes with isopropyl alcohol.

76. Fit parking sensors to new supplied housings to help locate housing during adhesive process

77. Check keying features on housings to ensure correct positioning of sensors.

- Far outside – 1x Notch (high spec only)
- Mid Outside – 2x Notch
- Inside - Flat

TOOLS REQUIRED

Isopropyl Alcohol,
Rag

FASTENERS



78. Break the bulb of the supplied Primer 94 ampule to activate the primer dispensing.
79. Apply Primer 94 to all areas adjacent to the parking sensor locations, on both the bar and the sensor housings.
80. Apply supplied VHB tape pads to all sensor housings as shown in the inset photo.
81. Dry fit sensors to bar to check loom position is correct.
82. Remove backing and adhere sensors in position in bar. Apply pressure for 10-30sec after positioning for best adhesion.
83. Connect all parking sensor loom connectors.
84. If parking sensors are not fitted, fit blanking plug to holes.

TOOLS REQUIRED

FASTENERS
VHB Tape pads
Primer 94 Ampule



<p>85. If fitting an integrated light bar, do so now.</p> <p>86. The bar is designed to fit an Offroad Animal 22in or light bar. If fitting this light bar, assemble bar with legs out, and it will line up with the slots in the center gusset. Secure with M8 Fasteners supplied with the light bar.</p>	<p>TOOLS REQUIRED</p> <p>13mm Spanner / Socket 4mm Hex Key</p>
<p>87. The bar can accommodate most other “20-22inch” size light bars.</p> <p>88. If fitting driving lights or top hoop to the bar this is also the most convenient time to do so. It is still possible later but is more difficult.</p> <p>89. After fitting driving lights, fit the Pan brace to the back of the bar, between the pan and center gusset using Supplied M6x16 (top) and M6x12 bolts, Flat washers, and Flange Nuts</p>	<p>FASTENERS</p> <p>Supplied with Light Bar</p> <p>3x M6x16 Black BHCS 3x M6x12 BHCS 6x M6 Flat washer 6x M6 Flange Nuts</p>

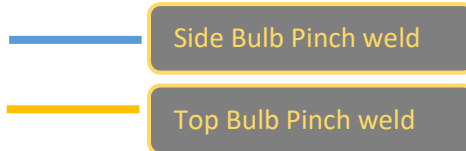
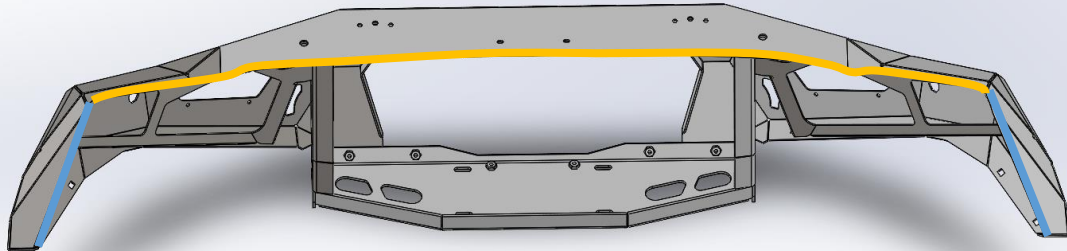

90. Fit Pinch weld to the bar as shown in the diagram above

TOOLS REQUIRED

FASTENERS

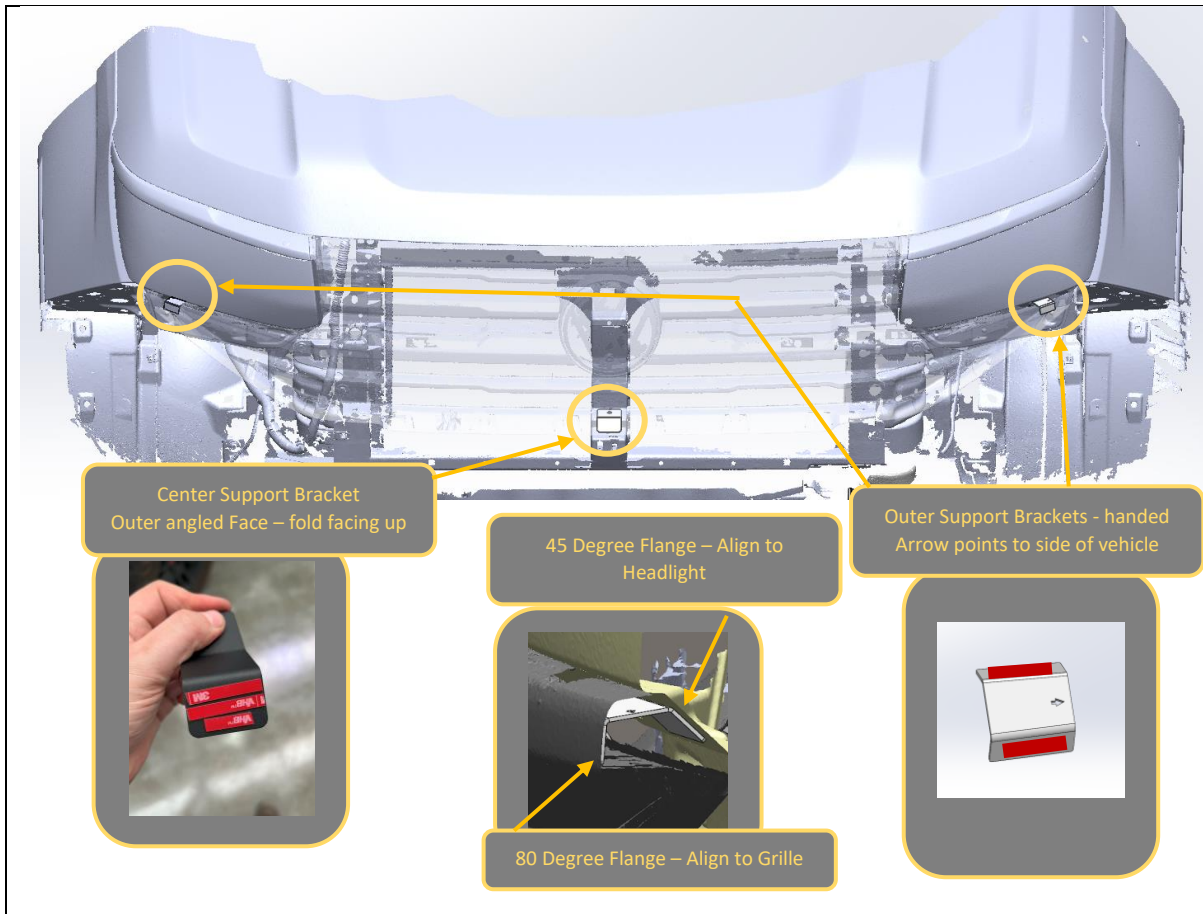

91. Using the same clean, prime, bond adhesive process as the sensors attach Tape Pads to both the inner and outer grille support brackets, Ensure correct faces are taped as per the diagrams above
92. Secure the center grille support bracket to the radiator support with M6x16 Button head bolt, Flat Washer, and Nut from small parts kit.
93. Using the VHB tape, bond the outer grille support brackets in place to the bottom section of headlight, in location and orientation shown in image.

TOOLS REQUIRED

FASTENERS

- VHB Tape pads
- Primer 94 Ampule
- 1x M6x16 Black BHCS
- 1x M6 Flat washer
- 1x M6 Flange Nuts



94. Panamericana and Aventura models have a different grille that will require a grille cut (detailed in steps 96&97) if fitting a winch.

95. If not fitting a winch the larger grille will fit in the same way as the smaller lower spec grille. Skip to step 98 Now

96. Place masking tape along the area indicated in the photo above. Ensure both the top grey and bottom black parts of the grille are clipped together properly. Mark trim as horizontal line 10mm below the "A M A R O K" Letters molded into the grille

97. Cut along the marked line, through both the top grey and bottom black layers using Air Hacksaw, Jigsaw and oscillating tool. Discard the bottom segment of the grill cut off.

TOOLS REQUIRED

Masking Tape
Marker
Straight Edge
Air Hacksaw

FASTENERS

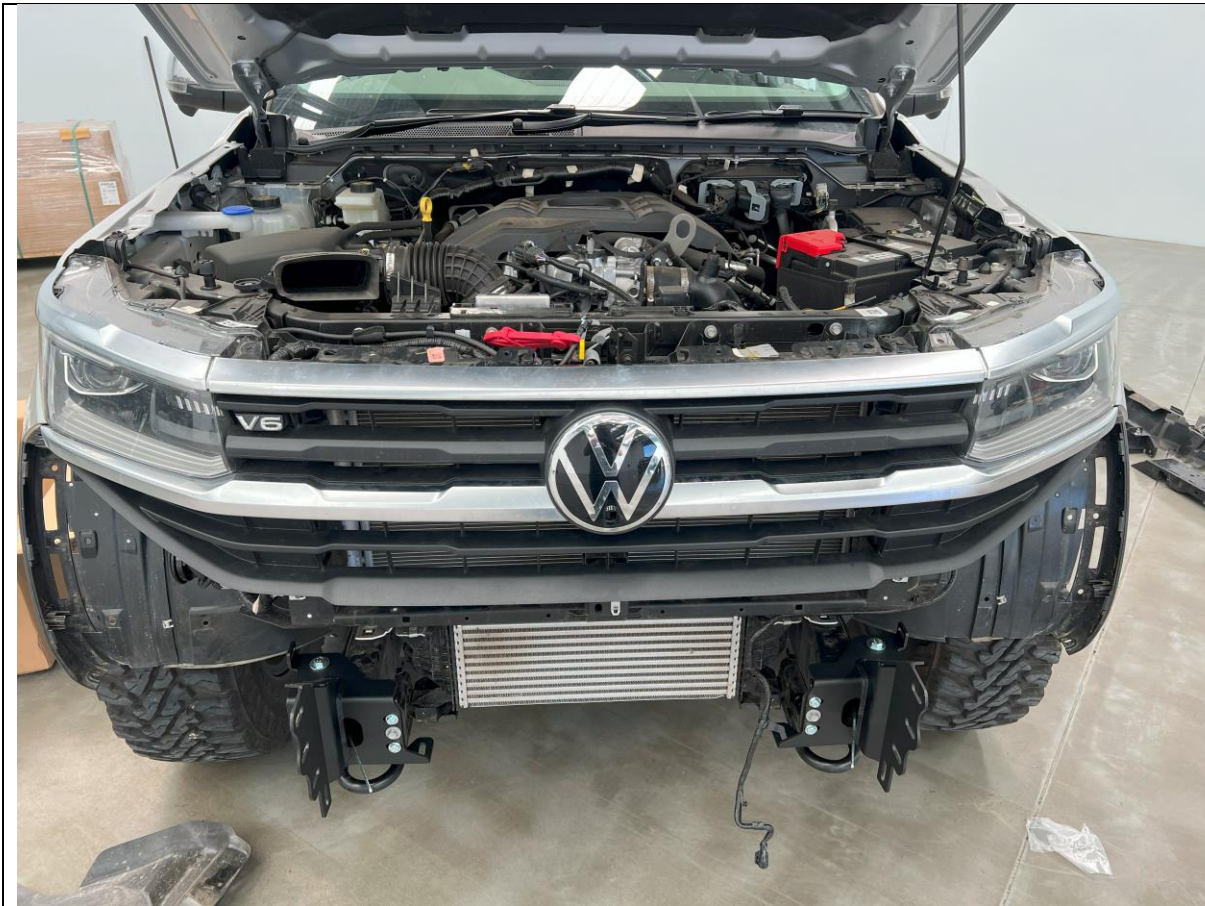

<p>98. Re-Fit the grille to the vehicle.</p> <p>99. Secure top of the grille with original bolts, leave loose at this stage.</p> <p>100. Pull forward bottom edge of grille to expose 3M tape on grille support brackets. Remove backing and bond grille to support brackets, applying even pressure for 20-30 seconds in each location.</p> <p>101. Tighten top grille support bolts.</p>	<p>TOOLS REQUIRED</p> <p>8mm Spanner / Socket</p>
	<p>FASTENERS</p> <p>OE Grille Bolts</p>



<p>102. Cut the flare along the line colinear with the bumper junction marked with masking tape before the bumper was removed.</p> <p>103. This can be done with an Air Hacksaw, Angle Grinder or Oscillating multi tool. Ensure cut is neat and straight.</p> <p>104. Complete on both sides of the vehicle.</p>	<p>TOOLS REQUIRED</p> <p>Air Hacksaw Or Oscillating multi tool Or Angle Grinder</p>
	<p>FASTENERS</p>

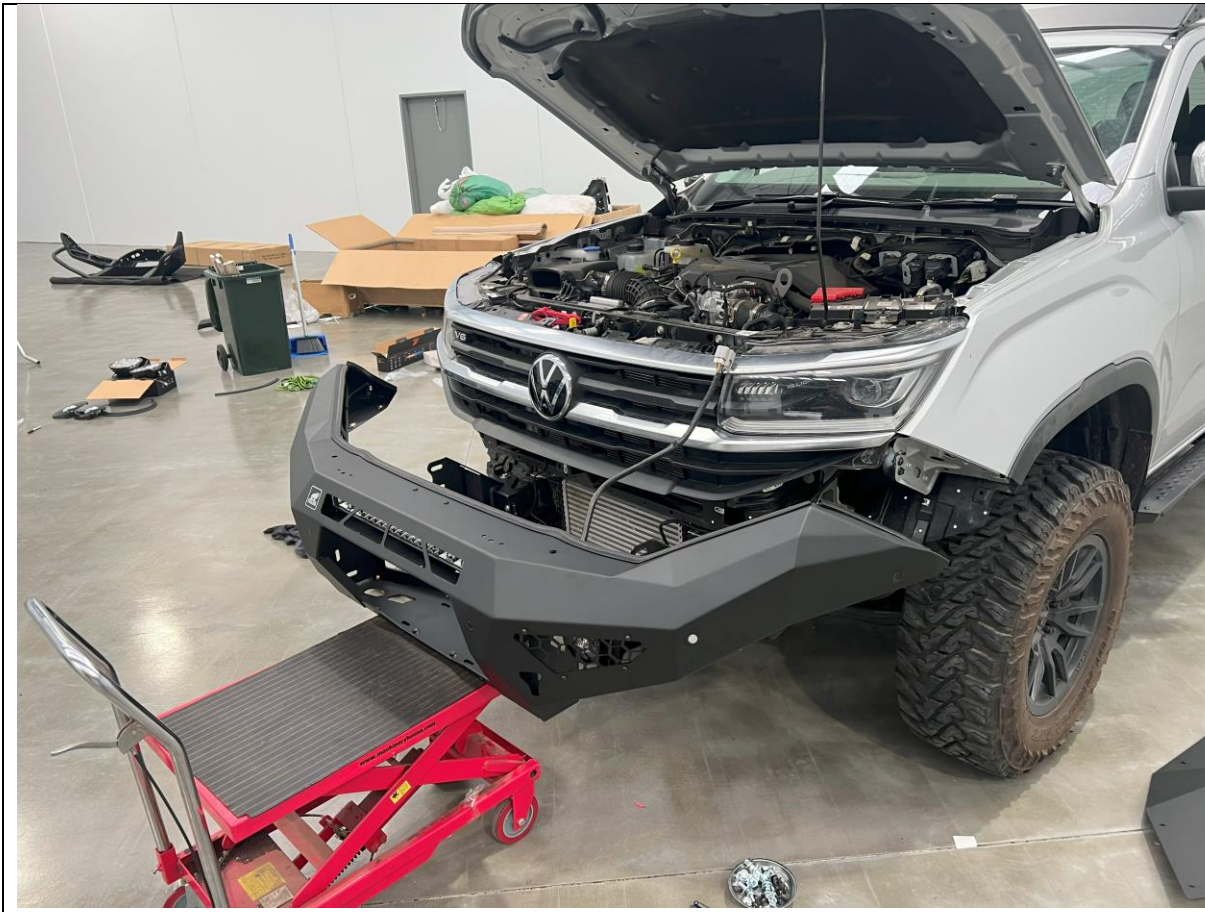

105. With assistance, either from another person, or a lifting trolley, lift the bar onto the mounts on the vehicle.
106. As the bar is fitted briefly unsecure top of grille and pass through the wiring harness into its original position
107. Secure with 4x M12x30 Bolts, Heavy Duty washers and M12 Nyloc and Flange Nuts per side, Finger tight at this stage.

TOOLS REQUIRED

Lifting Trolley

FASTENERS

8x M12x30 Bolt
12x M12 Heavy Duty Large Washer
2x M12 Nyloc Nut
12x M12 Flange Nut



<p>108. With assistance, from another person, Align the bar with the edges of the vehicle. Adjust such that the clearances are neat and even side to side.</p> <p>Acceptable range of clearances shown in image above.</p>	<p>TOOLS REQUIRED</p> <p>Lifting Trolley 18/ 19mm Socket and Spanner 4mm Hex Key</p>
<p>109. Once in position tighten the M12 Bolts using socket and spanner. An impact driver may be used to speed up this process.</p>	<p>FASTENERS</p>



110. If fitting a winch, do so now.
111. The bar is designed to fit most low mount winches, in foot down configuration. WARN ZEON 12 is largest winch confirmed to fit.
112. The control box can be mounted on top of the winch. Winches usually come with a bracket to allow this. Refer to winch manufacturer.
113. Ensure clutch handle will be accessible through access hole in front mesh panel. Refer to winch instructions regarding changing clutch handle location.

TOOLS REQUIRED

Refer to winch fitting instructions

FASTENERS

Supplied with winch



114. Fit the radar module to the Radar support plate and radar cover panel using M6x30 Black Button Head Bolts, Flat Washers, and Flange Nuts.
115. Fit the top bolt first. Place 2x Extra Flat washers between the U Bracket and radar module to maintain factory inclination of radar unit.

TOOLS REQUIRED

10mm Spanner
4mm Hex Key

FASTENERS

3x M6x30 Button Head
3x M6 Flange Nut
5xM6 Flat Washer

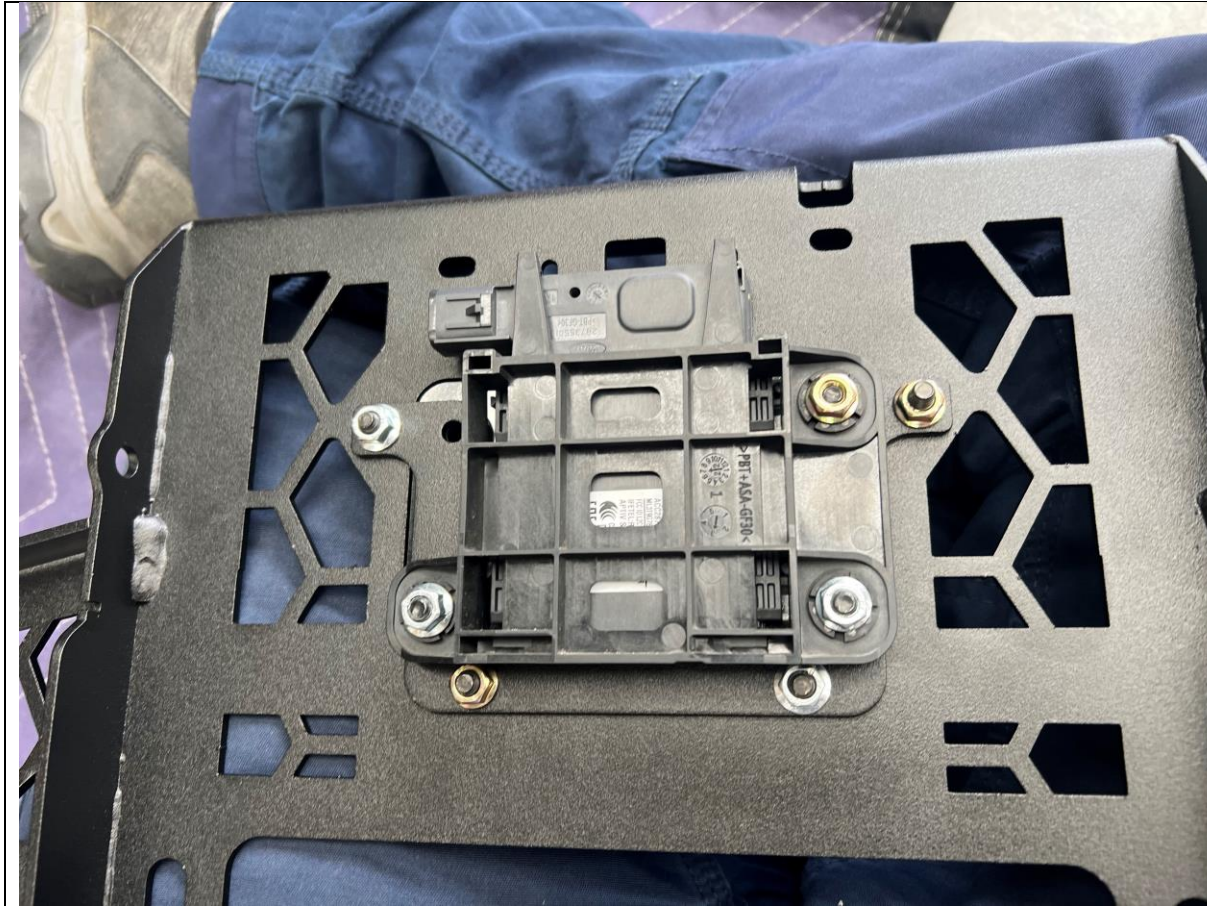

116. Fit the radar module on the support bracket to the main fairlead mesh panel using M6x16 Button head bolts, Flat washers, and flange nuts.
117. Fit M6x16 Button head, Flat washer and flange nut to final hole securing cover panel to radar bracket.

TOOLS REQUIRED

10mm Spanner
4mm Hex Key

FASTENERS

5x M6x30 Button Head
5x M6 Flange Nut
5xM6 Flat Washer



118. If Required, Fit winch fairlead to Mesh Fairlead Mount Use M10 or 3/8" Fasteners supplied with winch. The bar is only compatible with Hawse type fairleads.

119. Fit Number plate flip bracket to fairlead mount, M8x25 Bolt, Flat washer, Nylon washer and Nylon Lock nut. Ensure nylon washer sits between the bracket and fairlead mount.

120. **If Relocating Front Camera – Refit camera to mesh panel at this stage – Refer to Camera Relocation Kit instructions**

TOOLS REQUIRED

13mm Spanner
10mm Spanner
4mm Hex Key

FASTENERS

2x M8x16 Button Head
2x M8x20 Hex Head
2x M8 Flange Nut
4xM8 Flat Washer

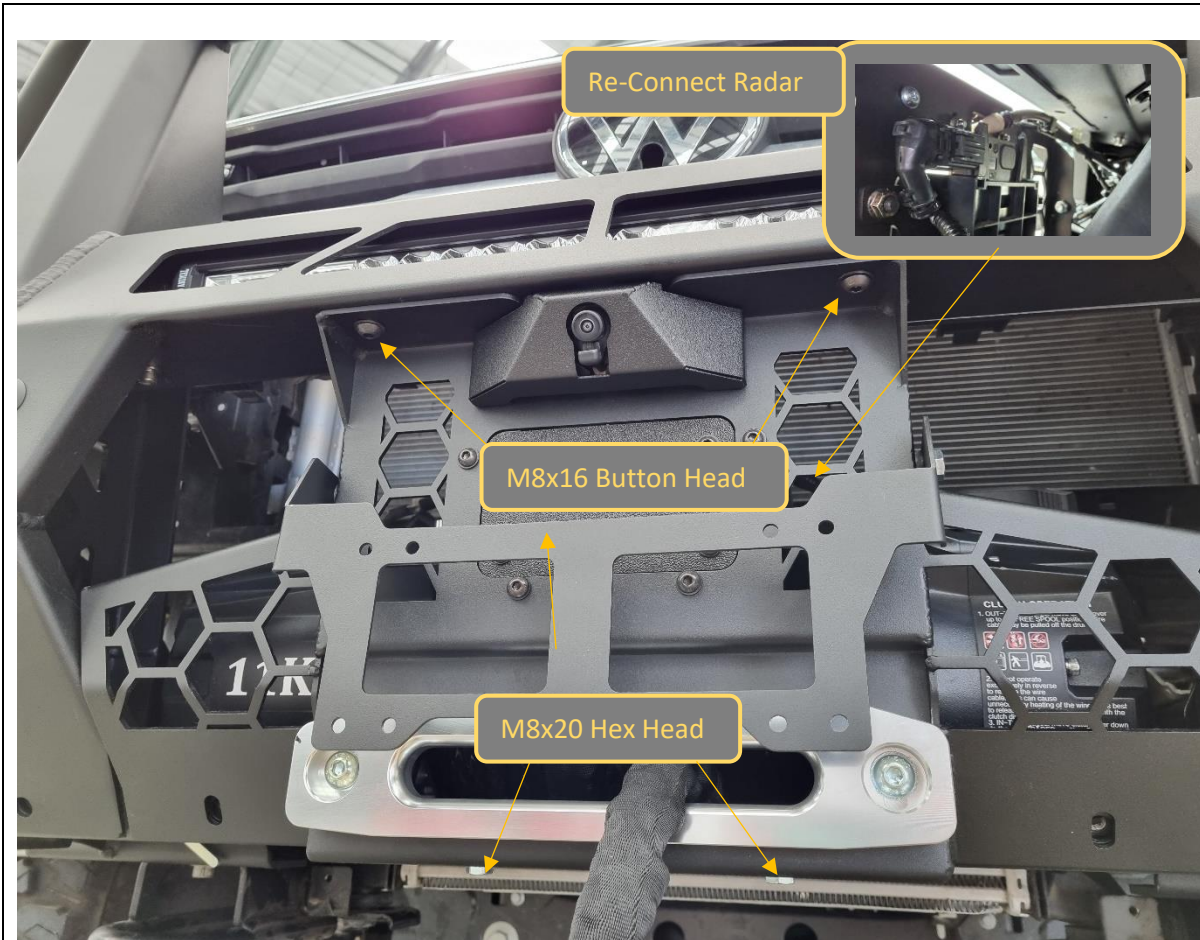

121. Fit the Mesh Fairlead Mount to the center of the bar, using M8x16 Button head (Top), M8x20 Hex (Bottom) M8 Flat washers
122. Tighten fasteners using 13mm socket / spanner and 5mm Allen Wrench.
123. Once fitted re-connect the radar sensor loom to the radar module now mounted in the fairlead

TOOLS REQUIRED

13mm Spanner
5mm Allen Wrench

FASTENERS

2x M8x16 Button Head
2x M8x20 Hex Head
2x M8 Flange Nut
4xM8 Flat Washer



- 124. Re Connect Electrical Harness, camera plug and camera washer hose.
- 125. Replace upper radiator cowl using original clips.

TOOLS REQUIRED

FASTENERS

Factory clips (re-use)

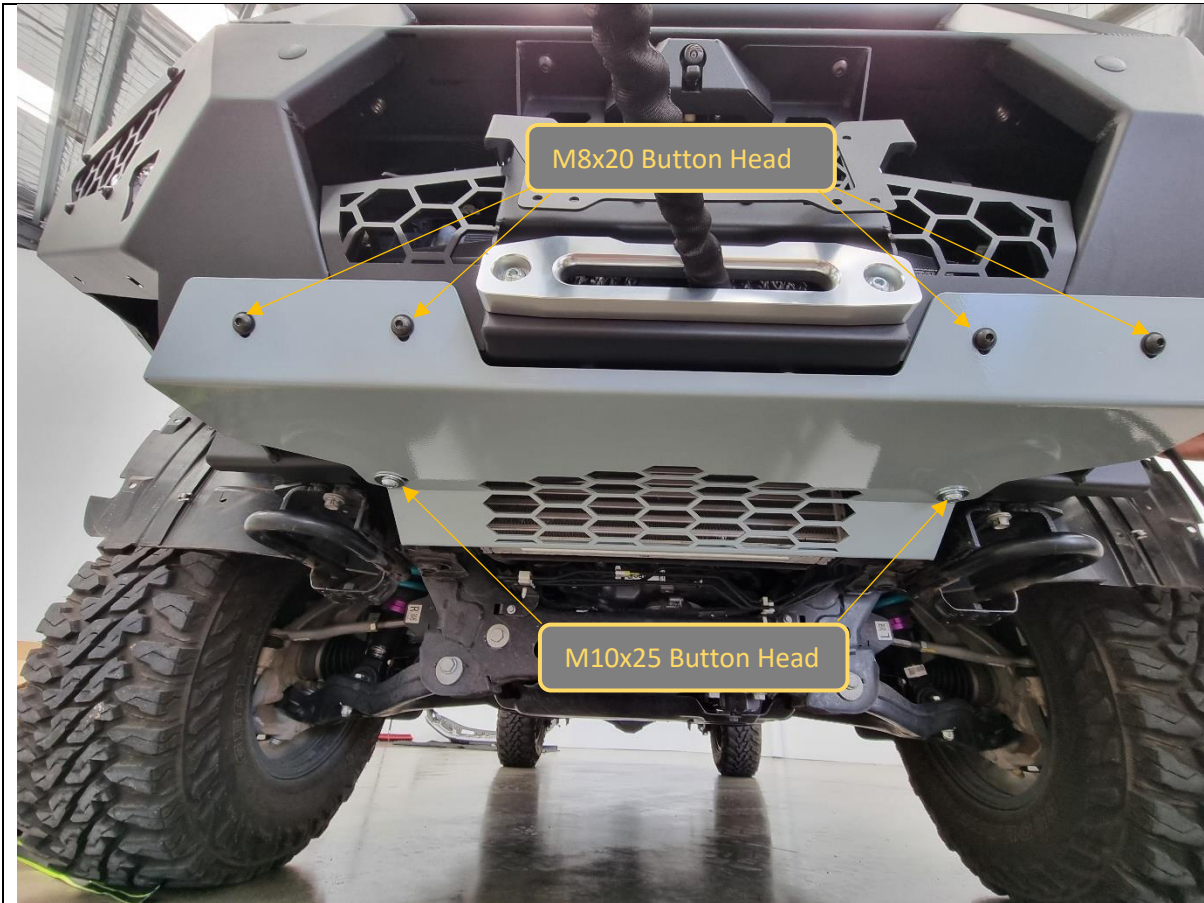

126. Fit Center Bash Plate using, M8x20 button head, flat washers.

127. Secure back of Center Bash Plate using supplied M10x25 Button head, backed by a supplied M10 Flange Nut.

128. Tighten Bottom fasteners using 6mm Hex key

129. Tighten front fasteners using 5mm Hex key.

130. Replace factory bash plate removed earlier using original bolts.

TOOLS REQUIRED

10, 13 mm Spanner
5 mm Allen Wrench

FASTENERS

4x M8x20 Button Head
4xM8 Flat Washer
2x M10x25 Button Head
2xM10 Flat Washer
2xM10 Flange Nut

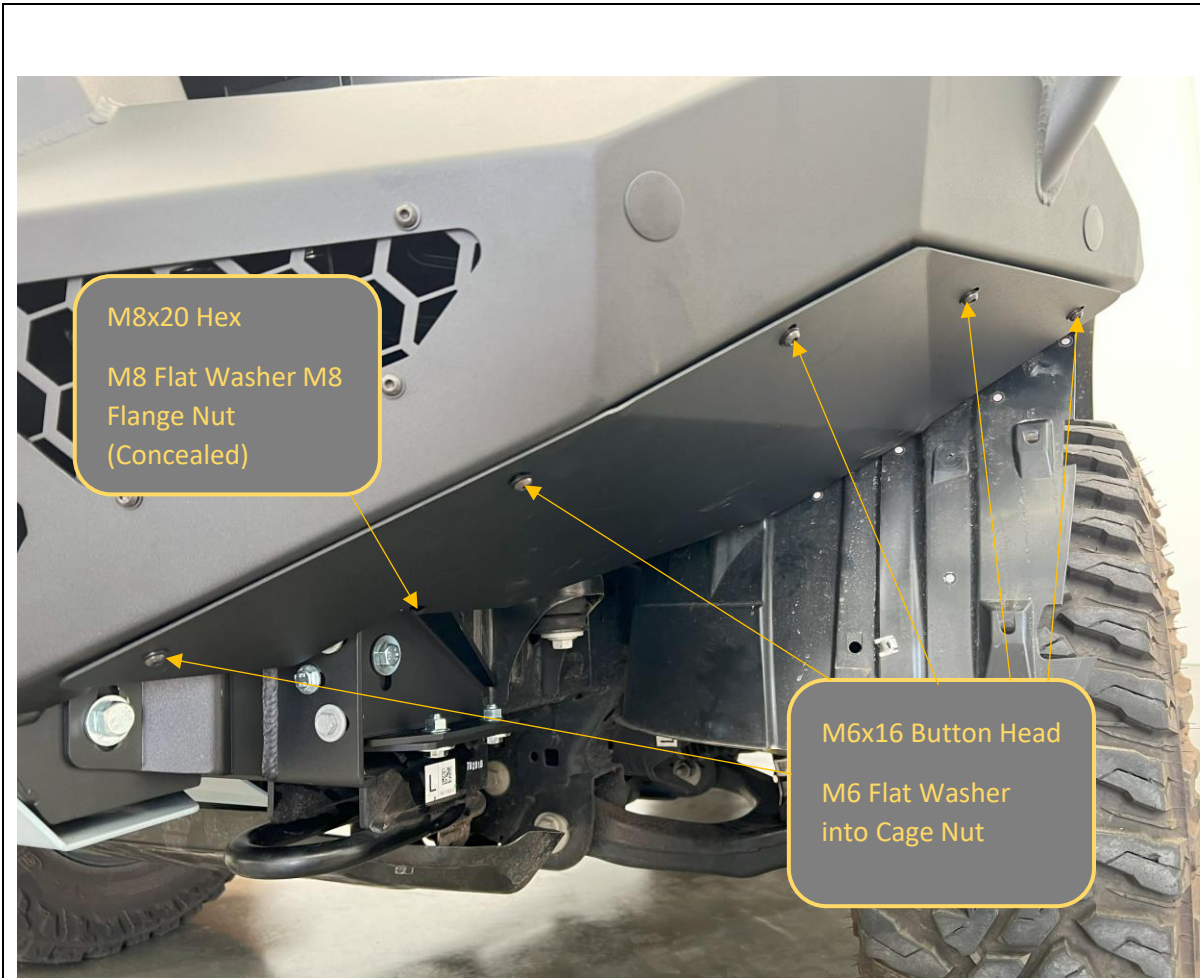

131. Fit Side Under panels using, M6x16 button head and flat washer into the cage nuts placed earlier.
132. Tighten with 4mm Allen wrench
133. Secure back of side under panel to tow point using M8x20 Hex Bolt, Flat washer, and M8 Flange Nut.
134. Leave finger Tight at this stage

TOOLS REQUIRED

FASTENERS

- 10x M6x16 Button Head
- 10x M6 Flat Washer
- 2x M8x25 Hex Head
- 2x M8 Flange Nut
- 2x M8 Flat Washer

TORO BARS ONLY

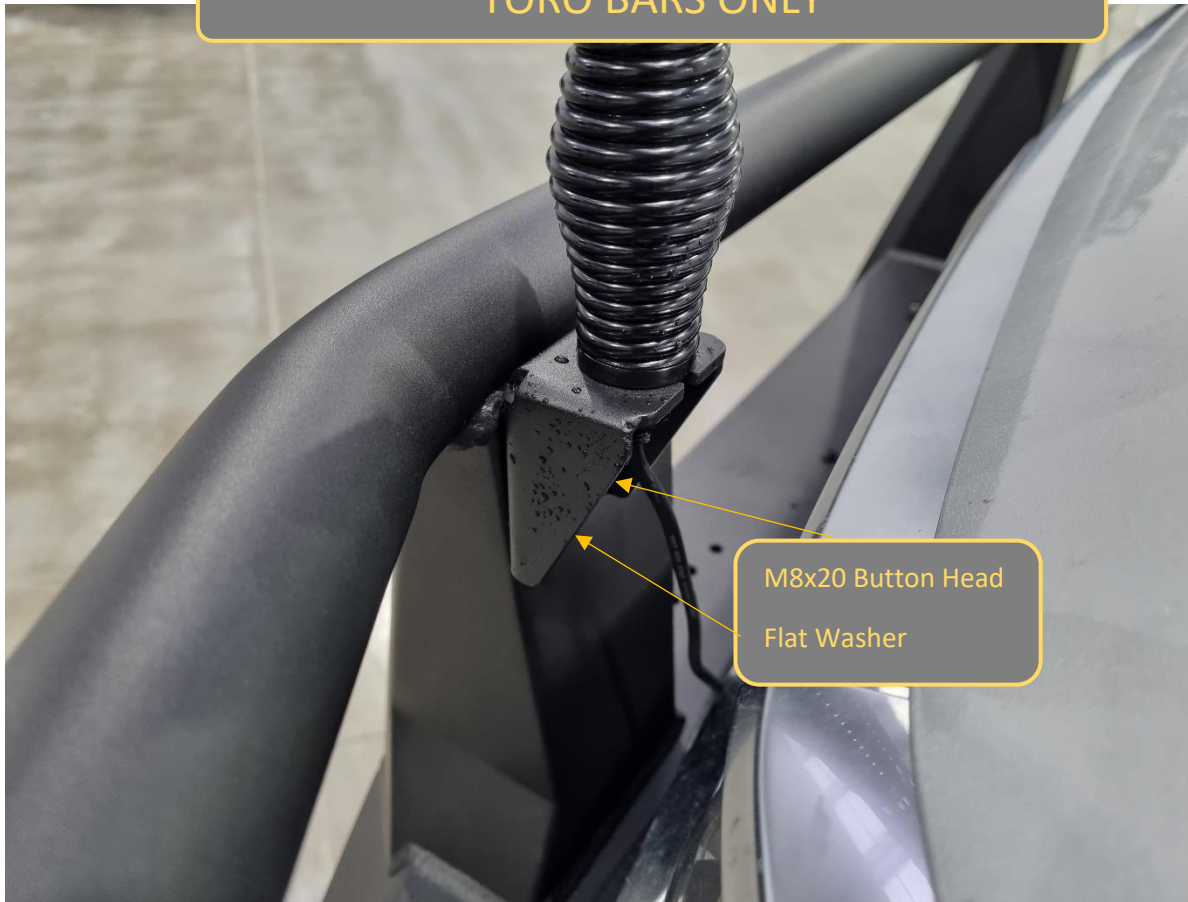

- 135. If required, fit antenna brackets to the threaded inserts behind bar upright using M8x20 Button Head bolts and Flat Washers.
- 136. Tighten with 5mm Allen wrench
- 137. Fit Antenna As required.
- 138. If not fitting antenna brackets retain and supply to customer for future use.

TOOLS REQUIRED

5mm Hex Key

FASTENERS

2x M8x20 Button Head Bolt
2xM8 Flat Washer



139. Using the edge of the under panel as a guide mark the wheel arch liner, approximately 15mm beyond the intersection of the under panel.
140. Cut along line as marked using utility Knife
141. Tuck the wheel arch liner behind the flange on the under panel
142. Tighten all under panel bolts
143. Complete for other side of vehicle.

TOOLS REQUIRED

- Utility Knife
- 13mm Spanner
- 5mm Allen Wrench
- 4mm Allen Wrench

FASTENERS



144. Check all Fasteners are tight.
145. **If Relocating Front Camera – Complete camera relocation steps - Refer to Camera Relocation Kit instructions**
146. Re-Fit number plate to number plate flip.
147. Head Bush and Enjoy your newly protected Amarok!

For contact details see www.offroadanimal.com