



Your 4x4 Accessory Adventure Partner.

FITTING INSTRUCTIONS

SB1-TOY-11

Stockman Bullbar

Toyota Hilux 2018-2020+



All EFS Bull bars have been tested and are airbag & ADR compliant.
ANY MODIFICATIONS TO THE bull bar or its mounts WILL VOID THIS
COMPLIANCY And warranty

BEFORE INSTALLATION

- Please read the instructions completely before installing. This will allow for easy installation and help to avoid scratches or other potential damages to the vehicle.
- images are for reference only and may differ slightly from the actual product you are installing. Whilst images may differ, they share the same assembly instructions.









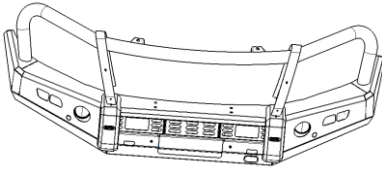
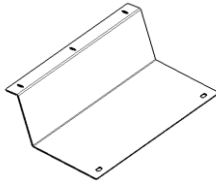
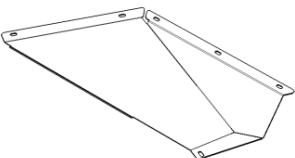
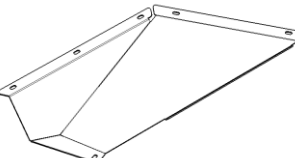
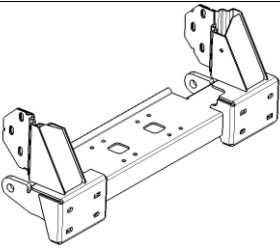
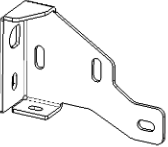
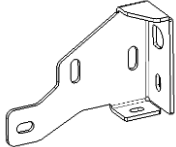
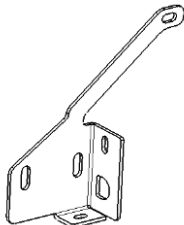
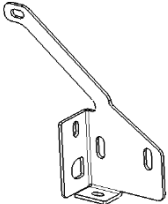
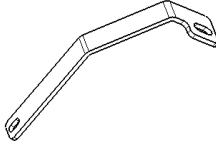
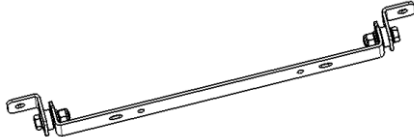
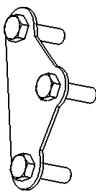

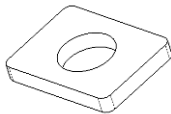
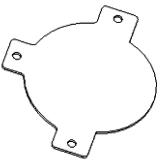
CARE & CLEANING

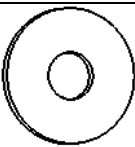

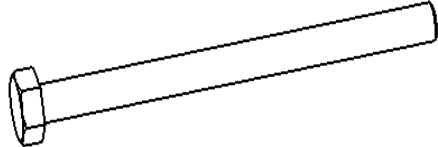

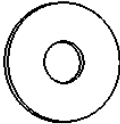

- Mild soap may be used to clean the bull bar.
- Check and retighten all the hardware regularly.

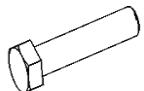
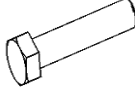
It is a condition of our warranty that Bullbar / Rearbars & Side rails / steps are installed by a suitably qualified installer. And is installed in accordance with accompanying installation instructions provided with item.



PARTS LIST

NO.	QTY	NAME	NO.	QTY	NAME
1	1	 Main bull bar Assembly	2	1	 Central Skid plate
3	1	 Skid plate (L)	4	1	 Skid plate(R)
5	1	 Winch Frame	6	1	 Bracket-1 (L)
7	1	 Bracket-1 (R)	8	1	 Bracket-2 (L)
9	1	 Bracket-2 (R)	10	1	 Mesh Bracket
11	1	 Number Plate Mounting Bracket	12	2	 Bolt Plate

13	4	 Metal Plate	14	2	 Fog Lamp Cover
Hardware List					
15	10	 Spring Washer D12	16	10	 Large Washer D12
17	4	 Flat Washer D12	18	10	 Hex Nut M12
19	4	 Hex bolt(Full Thread) M12_100	20	10	 Spring Washer D10
21	14	 Large Washer D10	22	4	 Hex Nut M10
23	4	 Hex Nut M10x1.25	24	4	 Cap Head Square Neck Bolts M10_40
25	2	 Hex Head Bolt (Full Thread) M10_30	26	4	 Hex Head Bolt (Full Thread) (Fine Thread) M10x1.25_45

27	8	 Hex Nut With Flange M6	28	24	 Bolt & Washer Assembly M6_20
29	1	 Large Washer D6	30	1	 Hex Nut M6
31	1	 Cross Pan head Screw and Flat Washer Assembly ST4_16	32	1	 Wrench S=4

Hardware list for Name plate mounting brackets

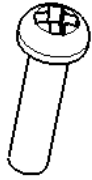
33	8	 Flat Washer D4	34	4	 Hex Nut M4
35	4	 Cross Recess Head Screw M4_16			

INSTALLATION FIG

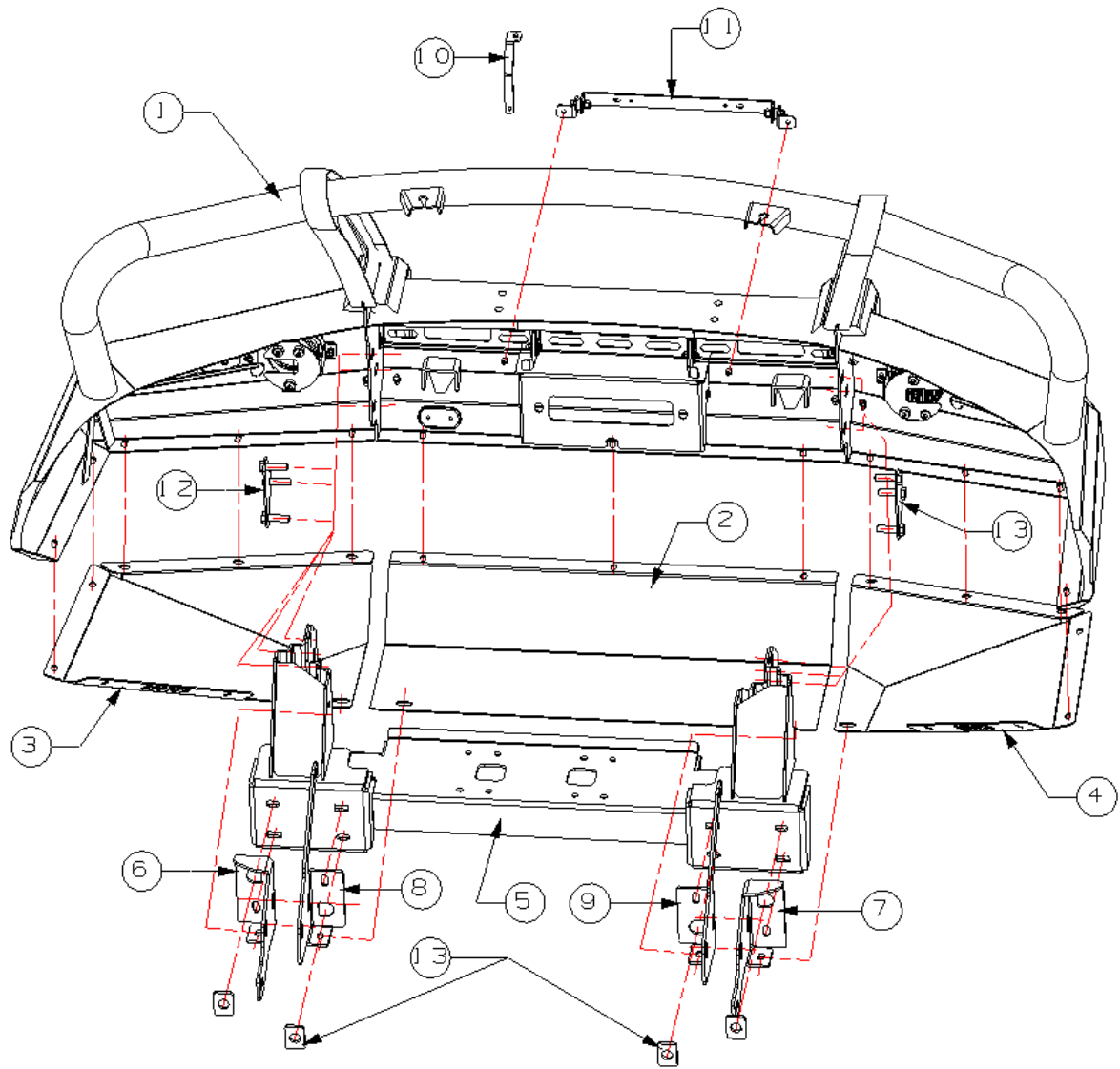

INSTALLATION INSTRUCTIONS

Step 1: Verify that all parts are present according to the manual. Remove the original front bumper and beam.



Step 2: Install the mesh plate bracket on the factory bracket (For 2018-2020 model)

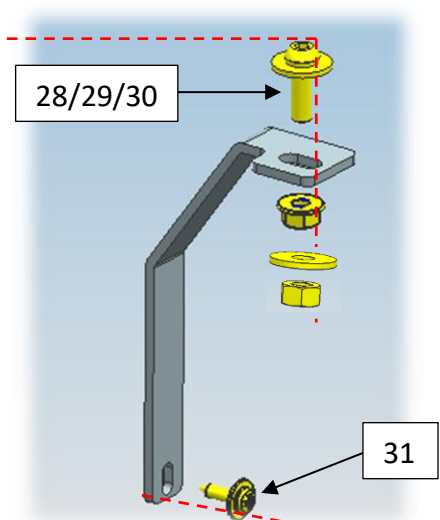
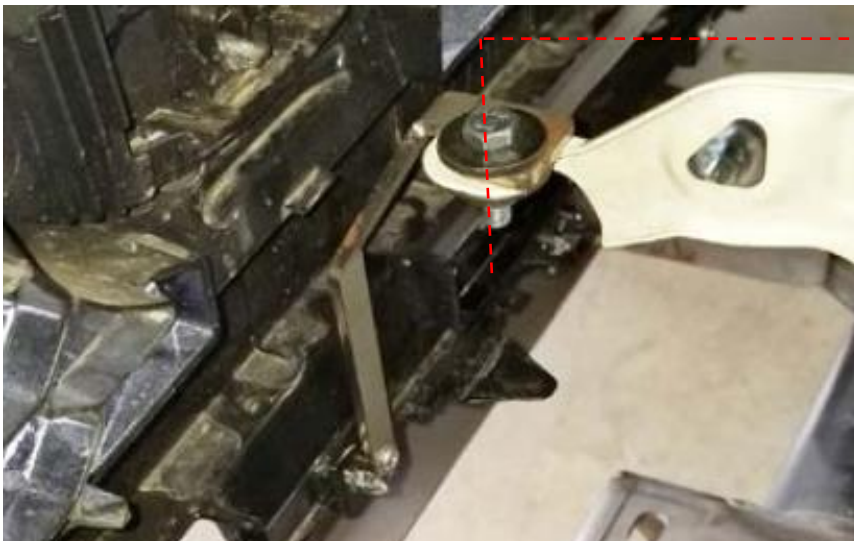

Step 3: Install Bracket - 1 and Bracket - 2 on both sides of the beam, fixed by hardware. Left and right are the same way.

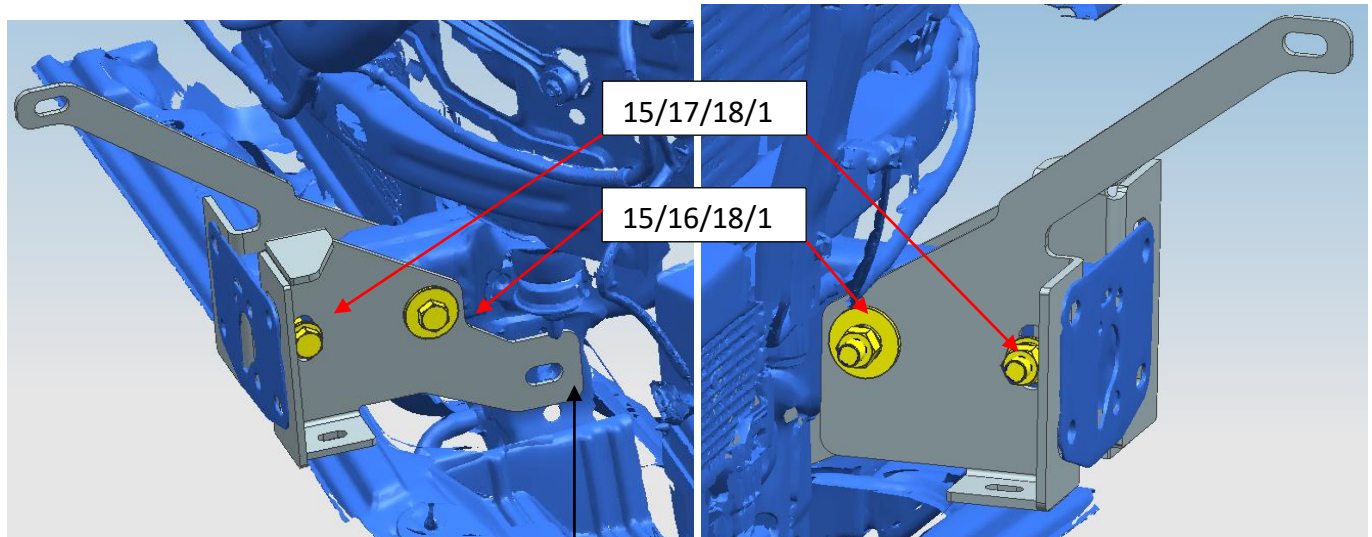

Install with factory bolts

Step 4: Connect brackets - 1 and brackets - 2 with winch frame as below:

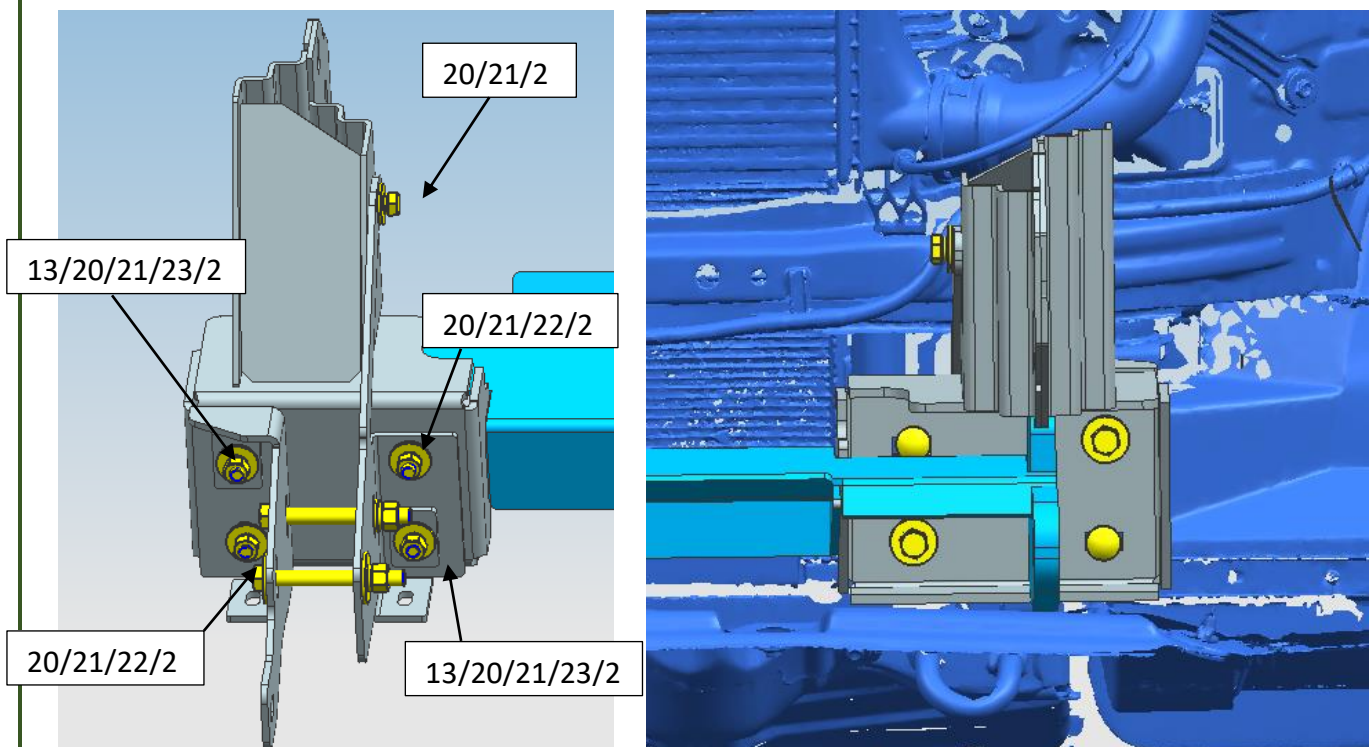

If you are installing a winch. Please proceed with this before moving to the next step.

Step 5: You will need to cut the bumper and grill and refit before attaching main bulbar assembly.
(Following pictures show where you will need to cut)



Step 6: Connect winch frame and main bull bar assembly by M12 bolt plate and hardware as below:

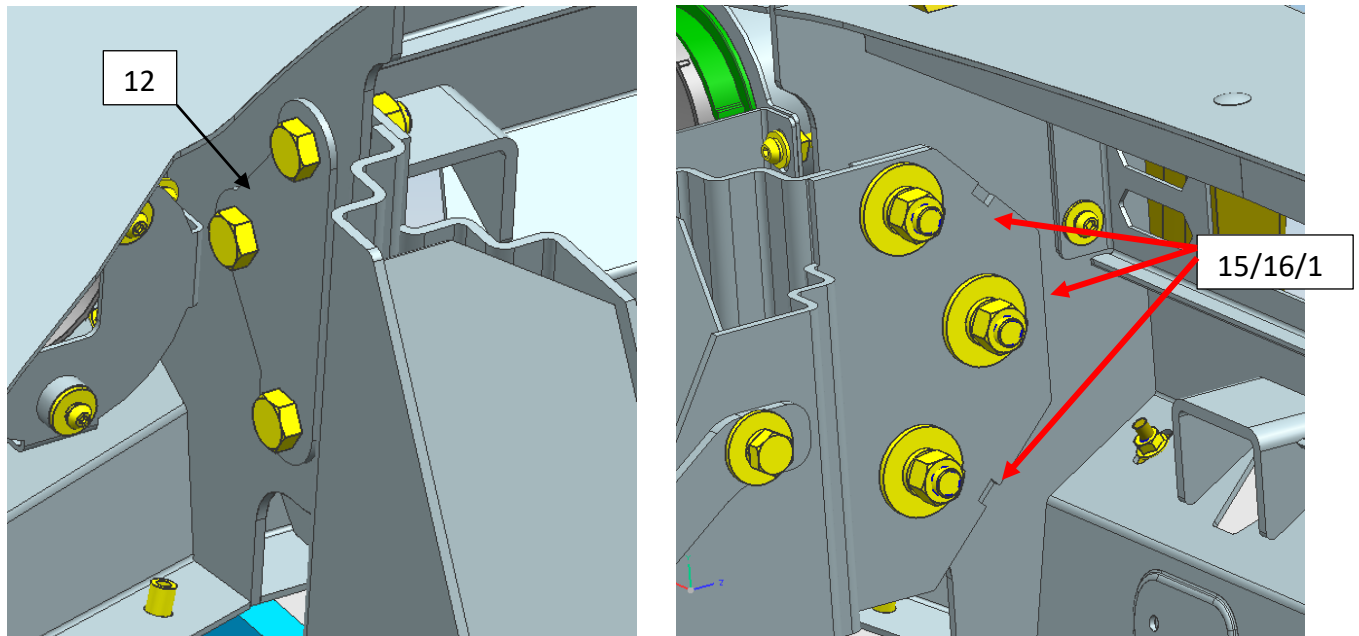

You will need to wire in the park/indicator lamp and fog lights in the bulbar to the vehicles wiring. The wire colors on the plugs are as follows.

Park/Indicator

Ground – Yellow

Park Light – Blue

Indicator – Brown

Fog Lights

Ground – Black

Power – Red

- Please use a test light to pick the appropriate wires to attach the plugs to.

- Ensure that the joined wires are covered with insulation tape or heat shrink and secure all wiring with cable ties.

Step 7: Fix the skid plates on the main body as pictured.

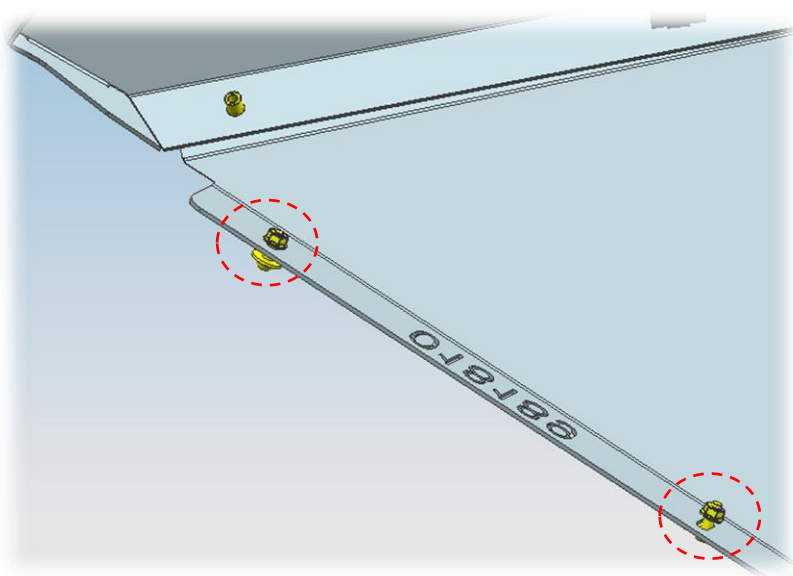
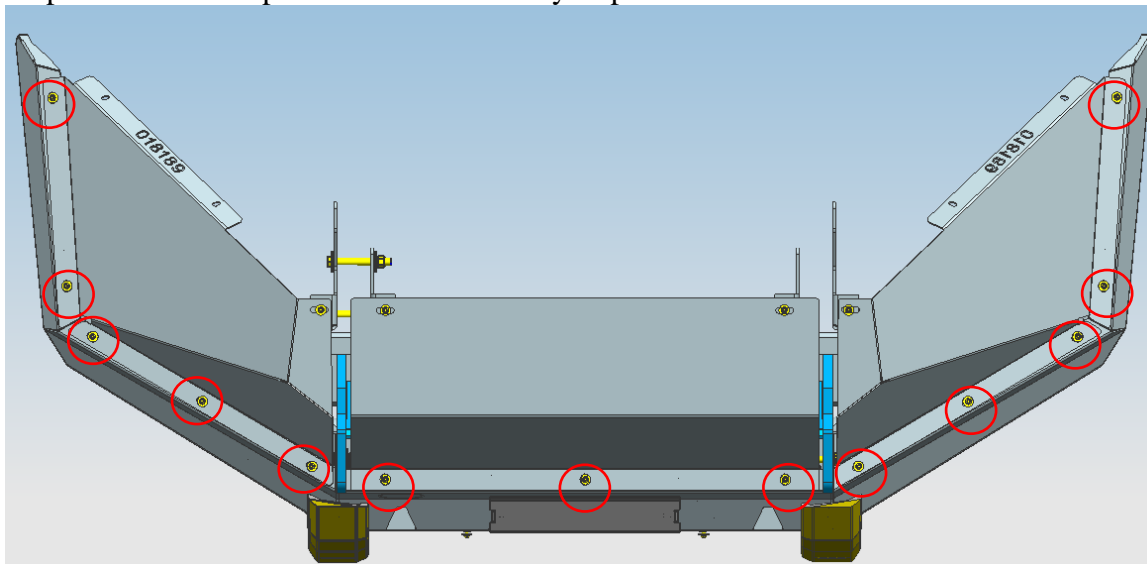

Step 8: Install number plate bracket as pictured.

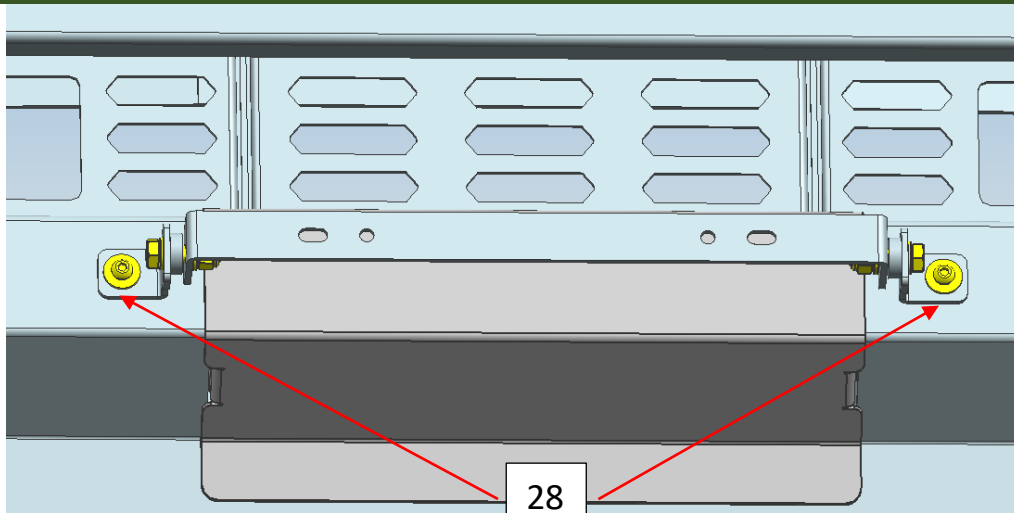

Step 8: Test and make sure that the guard is steadily fixed, fully tighten all hardware.

Step 9: Installation is finished, pick up all tools.

NOTE

Any damages or loss caused by the improper installation and use of EFS Accessories will not be covered by warranty.

Please ensure you leave sufficient spacing between bullbar and guards